

## Operating instruction for a safe operation of the flat knitting machine



| Name                        | Type | Component type |  | Name                            | Type      | Component type |
|-----------------------------|------|----------------|--|---------------------------------|-----------|----------------|
| CMS 933 ki                  | 777  | 000            |  | CMS 530 ki W<br>CMS 530 ki Bc W | 817       | 000 - 001      |
|                             | 778  | 000            |  | CMS 520 ki C                    | 818       | 000            |
| CMS 830 ki                  | 828  | 000 - 001      |  | CMS 520 ki C                    | 850       | 000            |
|                             | 829  | 000 - 001      |  | CMS 503 ki                      | 848       | 000            |
| CMS 830 ki C                | 830  | 000            |  |                                 | 849       | 000            |
| CMS 830 ki S                | 831  | 000            |  | CMS 502 ki<br>CMS 502 ki Bc     | 811       | 000            |
| CMS 822 ki                  | 826  | 000 - 001      |  | 812                             | 000 - 001 |                |
|                             | 827  | 000 - 001      |  | CMS 330 ki W<br>CMS 330 ki BW   | 814       | 000            |
| CMS 730 ki T                | 593  | 000            |  | CMS 330 ki W<br>CMS 330 ki BW   | 852       | 000            |
| CMS 703 ki                  | 847  | 000            |  | CMS 303 ki B                    | 834       | 000            |
| CMS 530 ki<br>CMS 530 ki Bc | 815  | 000 - 001      |  | CMS 202 ki B                    | 835       | 000            |
|                             | 816  | 000 - 001      |  |                                 |           |                |

Computer type for all machines: EKC2.0

Date: 2022-11-09

Translation of the original operating instructions

Operating system of the machine: V\_EKC\_002.004.000\_STOLL (or higher)

KARL MAYER STOLL Textilmaschinenfabrik GmbH, Adolf-Kolping-Str. 5, 72770 Reutlingen,  
Germany

Our products are being developed further continuously. They are therefore subject to technical modifications.

# Table of Contents

|       |   |    |
|-------|---|----|
| 1     | Documents about your knitting machine .....                             | 5  |
| 1.1   | How to find the documents about your knitting machine.....              | 5  |
| 2     | Safety instructions .....   | 7  |
| 2.1   | Intended use.....   | 7  |
| 2.2   | Organizational measures .....   | 8  |
| 2.3   | Personnel qualifications and selection .....                            | 9  |
| 2.3.1 | Personnel qualification .....   | 9  |
| 2.3.2 | Selection of personnel .....  | 10 |
| 2.4   | Symbols in this document .....  | 11 |
| 2.5   | Warnings .....  | 12 |
| 2.5.1 | Warnings used .....   | 12 |
| 2.5.2 | Explanation to the pictogram (ISO).....                                 | 14 |
| 2.5.3 | Warnings in the documentation .....                                     | 15 |
| 2.6   | Safety precautions regarding the machine's life phases .....            | 16 |
| 2.6.1 | Safety instructions for the transport .....                             | 16 |
| 2.6.2 | Safety instructions for installing .....                                | 17 |
| 2.6.3 | Safety instructions for the electrical connection .....                 | 17 |
| 2.6.4 | Safety Instructions for the Exchange of Data.....                       | 18 |
| 2.6.5 | Safety Precautions for Production .....                                 | 19 |
| 2.6.6 | Additional Safety Instructions for the Operation with Open Covers ..... | 21 |
| 2.6.7 | Safety Instructions for Lubrication, Cleaning and Maintenance .....     | 22 |
| 2.6.8 | Safety instructions for the repair .....                                | 23 |
| 2.6.9 | Safety instructions for dismantling work (dismantling) .....            | 28 |
| 3     | Technical data of the machine .....                                     | 29 |
| 3.1   | Dimensions and weights .....  | 29 |
| 3.2   | Electrical data .....   | 32 |
| 3.3   | Gauge ranges.....   | 34 |
| 3.4   | Operating conditions .....  | 35 |
| 3.5   | Storage conditions.....   | 35 |
| 3.6   | Noise emissions .....   | 36 |
| 4     | Main components of the knitting machine .....                           | 37 |
| 4.1   | Front side .....  | 37 |
| 4.2   | Lateral view (right).....   | 39 |
| 4.3   | Rear side.....  | 40 |
| 5     | Security relevant operating elements .....                              | 41 |

|        |  |     |
|--------|--|-----|
| 5.1    | Main switch.....   | 41  |
| 5.2    | Engaging Rod.....  | 42  |
| 6      | Optical and acoustic signal elements .....   | 43  |
| 6.1    | Signal light.....  | 43  |
| 6.2    | Touch screen.....  | 44  |
| 6.3    | Horn.....  | 45  |
| 6.4    | Lamp on the yarn control device .....  | 46  |
| 7      | Assembly and setting up .....  | 47  |
| 7.1    | Preparing assembly.....  | 47  |
| 7.1.1  | Preparing installation location .....  | 47  |
| 7.1.2  | Having tools and aids ready.....   | 47  |
| 7.1.3  | Transporting machine to installation location .....                                | 48  |
| 7.1.4  | Unpacking knitting machine .....   | 48  |
| 7.2    | Assembling machine .....   | 49  |
| 7.2.1  | Putting up knitting machine .....  | 49  |
| 7.2.2  | Connecting knitting machine, overview.....   | 53  |
| 7.2.3  | Connecting the knitting machine (mains voltage 230 V).....                         | 54  |
| 7.2.4  | Connecting the knitting machine (mains voltage 400 V).....                         | 60  |
| 7.2.5  | Connecting the knitting machine (mains voltage 230 V / 120 V, "Phase-Phase") ..... | 66  |
| 7.2.6  | Connecting the knitting machine (mains voltage 400 V, 3 phases) .....              | 72  |
| 7.2.7  | Connecting the knitting machine (mains voltage 400 V / 230 V) .....                | 77  |
| 7.2.8  | Connecting the knitting machine (mains voltage 230 V / 120 V, "Phase-Phase") ..... | 81  |
| 7.2.9  | Plug in battery pack .....   | 85  |
| 7.2.10 | Mounting the yarn guide device .....   | 87  |
| 7.2.11 | Mounting signal light .....  | 89  |
| 7.2.12 | Mounting friction feed wheel .....   | 90  |
| 7.3    | Aligning knitting machine.....   | 91  |
| 7.3.1  | Carry out Warmstart.....   | 92  |
| 7.3.2  | Aligning knitting machine .....  | 94  |
| 7.4    | Check the date and the time .....  | 96  |
| 7.5    | Glue on measuring tape .....   | 97  |
| 7.6    | Reducing wear during running-in period .....                                       | 97  |
| 8      | How to bring the carriage to an immediate standstill.....                          | 99  |
| 9      | Checking protective devices.....   | 101 |

# 1 Documents about your knitting machine

You can find documents about your knitting machine in the STOLL customer network.

<https://www.stoll.com/en/customer-net/>



- Operating instructions
- Safety Instructions
- Spare Parts Catalog
- Circuit diagram
- Online help
- Training documents...

The documents are available in different languages.

## 1.1 How to find the documents about your knitting machine

1. Call-up the STOLL customer network.  
<https://www.stoll.com/en/customer-net/>
2. Enter your access data (e-mail address and password).

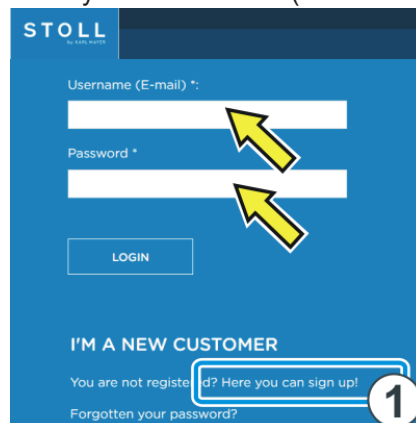

If you do not have any access data, tap the button (1).  
Fill in the form and send it to STOLL (button "REGISTER").

3. In the STOLL customer network select the following path:

Download Documentation + Tips and Tricks -> Download Documentation  
-> Select language -> Select machine

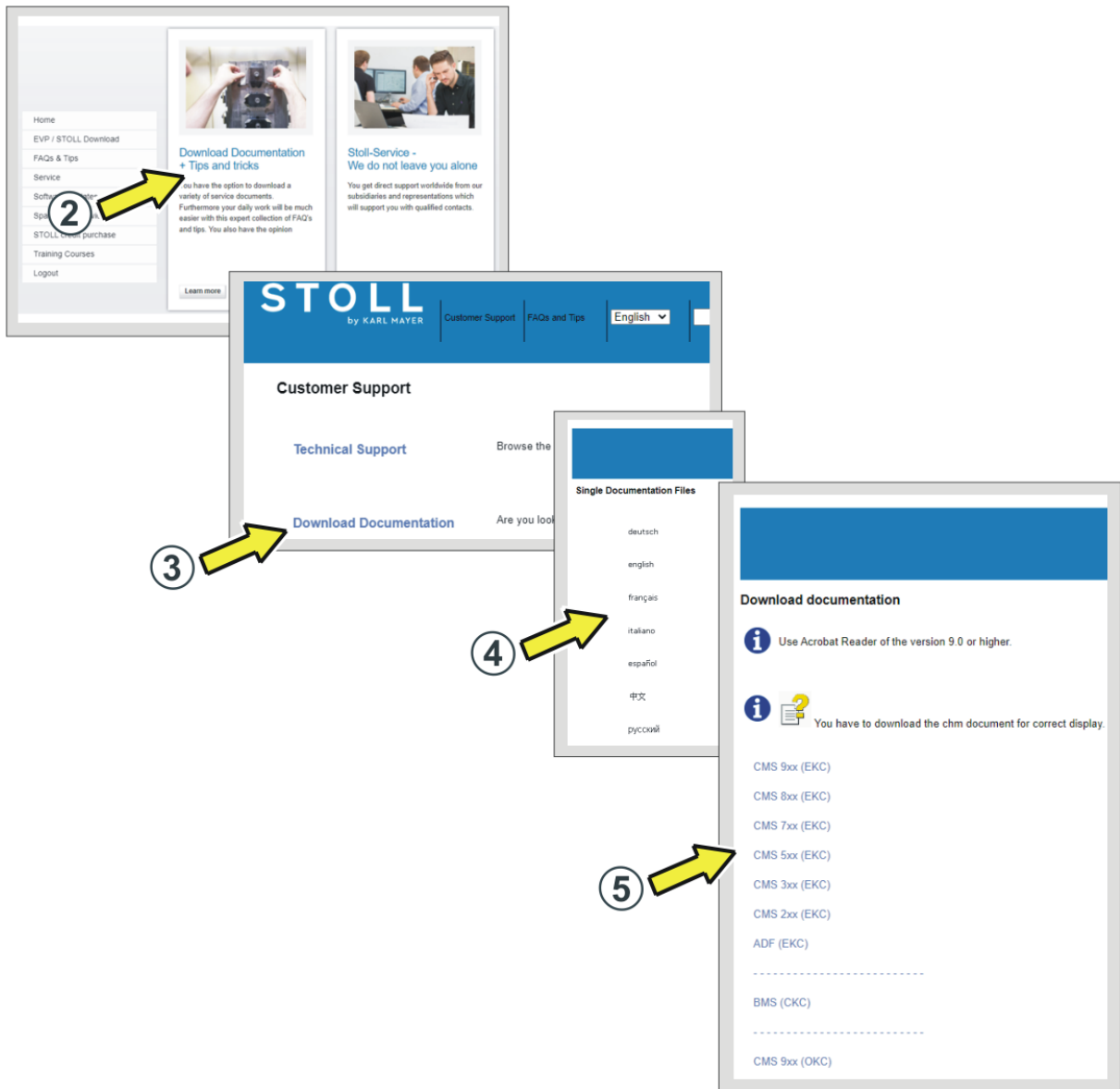

## 2 Safety instructions

### Foreword to the instructions

These operating instructions are designed to familiarize the user with the knitting machine and its designated use.

The operating instructions contain important information on how to operate the machine safely, properly and most efficiently. Observing these instructions helps to avoid danger, to reduce repair costs and downtimes and to increase the reliability and life of the machine.

The additional equipment of your machine can deviate from this description depending on the machine type (type of machine, scope of supply, special equipment).

The translations are carried out very carefully. Should you have any doubts about the accuracy of the translation, please compare this with the accompanying original document. In case of queries, please call the Stoll Helpline.

Further information is available via:

- the Stoll branch office or Stoll dealer in your country
- the Stoll Helpline:
  - Tel: +49-(0)7121-313-450
  - Fax: +49-(0)7121-313-455
  - E-mail: [helpline@stoll.com](mailto:helpline@stoll.com)
- Internet: <http://www.stoll.com>
- Training courses at the Stoll training centers



Preserve this operating instructions for future use. In case of reselling the machine, the operating instructions are to be included.

---

### 2.1 Intended use

The machine is an industrial knitting machine of the A class according to EN 55011.

**i** The knitting machine is not intended for use in residential areas. Radio interference can occur.

Observe the country-specific laws and regulations.

The sole purpose of this knitting machine is the production of stitched items. Only standard yarns are to be processed with the machine that are suitable for usage in industrial knitting machines.

The yarn guide elements are not designed for the safe conductance of high strength yarns or materials like for e.g. metals.

In case you have some specific requirements from the machine, kindly get in touch with any of the Stoll outlets.

## 2.2 Organizational measures

- The operating instructions are to be made accessible to all personnel who are responsible for working on the knitting machine.
- The operator must ensure that the contents of the operating instructions are clearly understood and can be applied by the personnel who are responsible for working on the machine.
- Apart from this the operator must ensure that the national/domestic regulations are observed and followed. They are for example regulations
  - for prevention of accidents,
  - for protection of health,
  - for environmental protection,
  - for technical rules and
  - for a safe and proper working.
- The knitting machine is to be used only in a technically sound condition and as per the stipulated conditions, awareness about the safety and dangers should be there and the operating instructions must be followed.
- The warnings on the machine are to be maintained in a complete and legible condition.  
Procurement of spare parts: see [12]
- No modifications, additions or conversions may be made on the machine that are not authorized by Stoll.
- Use only the original Stoll spare parts during repairs and maintenance.
- No arbitrary changes are to be made in the program in the operating system of the computer, the machine software and the controlling system/controls.
- No foreign software is to be installed in the machine.



## 2.3 Personnel qualifications and selection

- Any work on and with the machine must be executed by reliable personnel only.  
Observe the country-specific laws and regulations.

### 2.3.1 Personnel qualification

In order that the knitting machine can be operated correctly and safely, it must be set up and operated by reasonably skilled (qualified) personnel:

- Electrician
- Mechanic
- Knitting expert
- Trained or semi-skilled person

**Electrician** An electrician will be considered a person (expert in electrical area), who can assess and execute the electrical jobs assigned to him and can identify possible dangers.

The expert has the following characteristics:

- technical qualification
- theoretical knowledge
- practical experience
- Knowledge of the relevant (country specific) regulations
- Knowledge of the operating instructions

**Mechanic** A mechanic will be considered a person (expert in mechanical area), who can assess and execute the mechanical jobs assigned to him and can identify possible dangers.

The expert has the following characteristics:

- technical qualification
- theoretical knowledge
- practical experience
- Knowledge of the relevant (country specific) regulations
- Knowledge of the operating instructions

**Knitting expert** A knitting expert will be considered a person who can assess and execute the jobs assigned to him and can identify possible dangers.

The expert has the following characteristics:

- technical qualification on the knitting machine and the pattern design system
- theoretical knowledge
- practical experience
- Knowledge of the relevant (country specific) regulations
- Knowledge of the operating instructions

**Trained or semi-skilled person** A trained or semi-skilled person is considered as someone who, based on the following characteristics can carry out definite, accurate tasks on the knitting machine.

- detailed theoretical and practical orientation on the knitting machine
- practical experience
- Knowledge of possible dangers

### 2.3.2 Selection of personnel

- The operator must ensure that only personnel authorized for the same can work on the machine.
- The responsibilities of the personnel are to be laid out very clearly for the following activities.

The table shows the minimum requirements for each personnel.

| Activity                       | Personnel                                       |
|--------------------------------|---|
| Assembly                       | Mechanic  |
| Electrical Connection          | Electrician                                     |
| Setting up                     | Knitting expert                                 |
| Programming                    | Knitting expert                                 |
| Patterning                     | Knitting expert, trained or semi-skilled person |
| Setting up                     | Knitting expert, trained or semi-skilled person |
| Operation                      | Knitting expert, trained or semi-skilled person |
| Production                     | Trained or semi-skilled person                  |
| Maintenance, care and cleaning | Knitting expert, trained or semi-skilled person |
| Maintenance                    | Mechanic, electrician or knitting expert        |
| Repair                         | Mechanic or Electrician                         |
| Dismantling work               | Mechanic or Electrician                         |

## 2.4 Symbols in this document

Some information in this document are marked with special symbols to make it easier to access this information quickly.

- ★ The additional equipment of your machine can deviate from this description depending on the machine type (type of machine, scope of supply, special equipment).

---

**i** Background information is provided here.

---

 Tips for optimal procedure are provided here.

---

|   |   |
|---|---|
|  | <b>DANGER</b>   |
|   | <p><b>A warning is given here!</b></p> <p>A warning protects you from death or injuries and the knitting machine from serious damage.</p> <p>→ Always read warnings carefully and observe them exactly.</p> |

One-step action Carry out an one-step action:

- ✓ Condition for the following action.
- Carry out one-step action.

Multi-step action Carry out a multi-step action:

- ✓ Condition for the following actions.
- 1. Carry out first action.
- 2. Carry out second action.
  - ▷ Result of the action carried-out.
- 3. Carry out third action.
  - or -
  - Carry out the alternative action for point 3.
- ▶ Result of the action sequence.

---

 If something fails to function properly:  
Information on the possible causes is provided here.  
To solve the problem, carry out the action described here.

---

## 2.5 Warnings



In this chapter you will find explanations to the warnings on the machine and in the documentation.

### 2.5.1 Warnings used

Warnings on the machines correspond to the standard ISO 3864-2.

Scope of validity: all countries except USA and Canada

A warning as per ISO 3864-2 can comprise of the following elements:

| Pictograph  | Explanation                                    |
|---|--|
|    | one or more warning indications                |
|    | one or more prohibitive indications (optional) |
|  | one or more commands (optional)                |

Elements of a warning

Site for labeling the warning on the machine

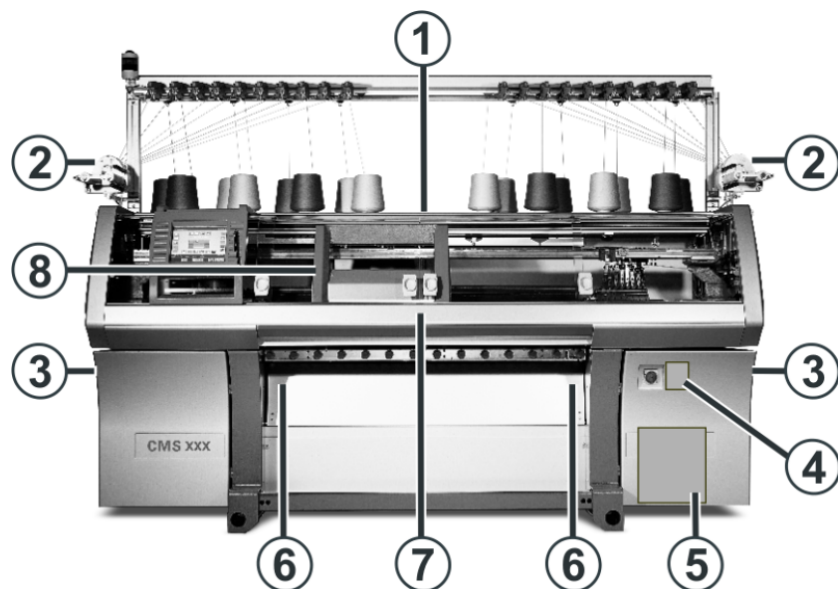









Site for labeling the warning on the machine

List of warnings on the machine

**i**













Warnings have to be maintained in a complete and legible condition at all times.  
The order numbers of the labels are found in the following table.

| No. | Warning   | Explanation   |
|-----|---|---|
| 1   |  <p>ID 244 266</p>   | Warning on the rear panel   |
| 2   |  <p>ID 244 274</p>   | Warning on the friction feed wheel  |
| 3   |  <p>ID 244 265</p>  | Warning on the panelling of the control cabinet right and left  |
| 4   |  <p>ID 244 267</p> | Warning front cover main switch   |
| 5   |  <p>ID 244 275</p> | Warning on the base plate control cabinet right and rear panel control cabinet right  |
| 6   |  <p>ID 244 268</p> | Warning on the comb take-down   |
| 7   |  <p>ID 244 264</p> | Warning under the covers  |
| 8   |  <p>ID 244 273</p> | Warning on the central lubrication of front and rear needle beds.<br>For tandem machines, on right-hand side of right carriage as well. |

List of warnings

### 2.5.2 Explanation to the pictogram (ISO)

Pictograms on the machine

| Type                   | Pictograph  | Explanation  |
|------------------------|---|--|
| Warning indication     |    | General warning indication                                       |
|                        |    | Dangerous electrical voltage                                     |
|                        |    | Danger of crushing and cutting                                   |
|                        |    |  |
|                        |   | Danger from flying-off mechanical parts or lubricating materials |
|                        |  | Danger of suction  |
| Prohibitive indication |  | Prohibit rear panel removal                                      |
|                        |  | Prohibit panelling removal                                       |
|                        |  | Prohibit intervention  |
| Command                |  | Wear safety glasses  |
|                        |  | Disconnect mains supply  |
|                        |  | Wear hair protection gear  |
|                        |  | Wait till all LEDs on the control cabinet are off                |

Pictographs used on the knitting machine

### 2.5.3 Warnings in the documentation

The warnings in the documentation have the following structure:

- Safety sign  
The safety sign warns about the danger of injury and death. In order to avoid death and injuries, all measures that are indicated along with the safety sign are to be followed.
- Signal word  
DANGER, WARNING, CAUTION, IMPORTANT
- Signal color  
depending upon the signal word: red, orange, yellow, blue
- Text comprises of:
  - Type and source of danger
  - Possible outcomes
  - Measures for protection against danger and prohibitions

Example:

|   |  |
|---|--|
|  | DANGER   |
|   | <p><b>Life-threatening high voltage!</b><br/>Electrical shock may cause death or serious injuries.</p> <p>→ Set machine main switch to "0".</p> <p>→ Secure the machine against being switched on again.</p> |

| Signal word | Explanation  |
|-------------|--|
| DANGER      | Imminent danger of death or serious injuries (irreversible). |
| WARNING     | Death of serious injury (irreversible) possible.             |
| CAUTION     | Slight injury (reversible) possible.                         |
| IMPORTANT   | Damage to property possible.                                 |

Explanation to the signal words

## 2.6 Safety precautions regarding the machine's life phases

- Avoid any operational mode that might be prejudicial to safety.
- Take the necessary precautions to ensure that the machine is used only when in a safe and reliable state.
- Operate the machine only when all the protective and security equipment is available and functional.
- In particular, malfunctions which could limit the safety of the machine are to be remedied (or repair is to be commissioned) immediately!
- Observe the warnings on the machine and in the operating instructions by all means. By doing so you will protect yourself and the others from dangers and will help to avoid damages to the machine and other tangible assets.
- No one may remain inside the machine. Risk of death!
- Observe the start-up and shut-down procedures and the indicators.
- Before starting up or setting the machine in motion, make sure that nobody is at risk!

### 2.6.1 Safety instructions for the transport

| Type of risks                    | Measures   |
|----------------------------------|--|
| Danger of injury by heavy loads. | <p>Country-specific regulations for the prevention of industrial accidents for the transport of heavy loads are to be observed.</p> <p>Use only appropriate means of transport with sufficient load capacity for transporting and installing the knitting machine (e.g. fork lift).</p> <p>The relevant country-specific laws and regulations are to be observed when transporting with a ground conveyor (e.g. fork lift).</p> <p>Ground conveyor: observe the safety instructions of the manufacturer.</p> <p>Transport the machine always with the utmost caution and care.</p> |
| Danger of damage to the machine. | Attach all the transport locks.  |



## 2.6.2 Safety instructions for installing

| Type of risks                    | Measures   |
|----------------------------------|--|
| Danger of injury by heavy loads. | Observe all technical data of the machine.<br><br>Country-specific regulations for the prevention of industrial accidents for the transport of heavy loads are to be observed. |
| Danger of damage to the machine. | Remove all transport locks.<br><br>Connect side protective shrouding (on left and right-hand sides of machine).  |
| Environment pollution            | Dispose of protective films in an environmentally responsible manner.<br><br>Observe the country-specific laws and regulations.  |

## 2.6.3 Safety instructions for the electrical connection

| Type of risks   | Measures   |
|---|--|
| Danger to life during work on the electrical assembly of the machine. | Get the machine connected by an electrician.<br><br>Note technical data. |

### 2.6.4 Safety Instructions for the Exchange of Data

| Type of Risks   | Measures   |
|---|--|
| <p>Computer viruses!<br/>Loss of data or production.<br/>Computer viruses can creep into the machine through unscanned data via USB sockets or network.</p> | <p>Bring in only virus free data on to the knitting machine.</p> <p>The dangers associated with computer viruses have been increasing for years. Look into the subject and ensure that the network computer connected with the knitting machine and the data carrier used on the knitting machine are free from computer viruses!</p> <p>We advise you with emphasis to the fact that the company Stoll will take no guarantee or responsibility for damages in this conjunction. For further enquiries please contact Stoll-Helpline.</p> |

### 2.6.5 Safety Precautions for Production

| Type of risks  | Measures   |
|--|--|
| <p>Danger of injury</p>                                      | <p>Close the covers.<br/>                     Close the rear panels of the machine.<br/>                     Close the lateral covers.<br/>                     Keep eyes away from the lateral yarn tensioner.<br/>                     Objects such as tools, bobbins etc. to be removed from the inside of the machine.<br/>                     If the machine is in operation, under no circumstances should you reach into it.<br/>                     Stop the machine if an intervention is necessary.<br/>                     Do not tear off the yarn by hand but use scissors.</p>  |
| <p>Danger of winding and suction and danger of crushing.</p> | <p>Do not reach into the fabric take-down rollers.<br/>                     Do not touch the friction feed wheel while the machine is in operation and keep away loose garments and hair strands.<br/>                     Wait for the feed wheel to stop moving after stopping the machine.</p>  |
| <p>Health hazard by fibers, dust and fumes.</p>              | <p>Special caution is to be observed while knitting of yarns that cause health hazards or a damage to the machine:</p> <ul style="list-style-type: none"> <li>◆ Yarns with heavy fiber fly</li> <li>◆ dyestuffs causing health hazards</li> <li>◆ Yarns made of glass fibers, metallic-annealed fibers, asbestos, carbon, PU or similar materials</li> </ul> <p>Employ suitable measures to avoid the hazard caused by fibre, dust and fumes.<br/>                     Observe the country-specific laws and regulations.<br/>                     Observe the manufacturer's specifications (safety data sheet).<br/>                     For any further queries please contact Stoll.</p> |

---

Safety precautions regarding the machine's life phases

| Type of risks  | Measures   |
|--|--|
| Fire hazard by fluff, dust and other impurities.<br>Increased danger of short circuit during knitting of metallic or conductive materials by building up of conductive fluff and dust. | Fluff, dust and other impurities to be removed regularly from the entire machine depending upon the degree of dirt at least once in every shift.<br>Take care of any additional suction.<br>Wear Inhalation protection gear. |

### 2.6.6 Additional Safety Instructions for the Operation with Open Covers

If the covers are open the engaging rod cannot be locked into its highest position (production). The user must hold the engaging rod in this position so that the machine works at the set speed "MSECCO" (dead man's switch).

The maximum carriage speed with open cover can be set in the "Machine parameter" window. (Value range in input field "MSECCO": 0.00 to 0.20 m/s, default: 0.05)

|   |   |
|---|---|
|  | <b>DANGER</b>   |
|   | <p><b>The carriage moves at production speed!</b></p> <p>Danger of crushing and cutting by the carriage.</p> <ul style="list-style-type: none"> <li>✓ If the "MSECCO" check box is deactivated, the carriage moves at production speed.<br/>After the reversal point, the carriage can move at higher speed, if it is set up that way in the knitting program.</li> <li>→ Close the covers.</li> <li>→ Do not deactivate the "MSECCO" check box.</li> </ul> |

| Type of risks  | Measures   |
|--|--|
| Danger of crushing and cutting by the carriages, racking, the needle beds, the clamping and cutting devices and the additional needle beds.  | Do not reach into the running machine.<br><br>Move carriage step by step or at creep speed (see operating instructions).   |
| Danger of injury by broken cam box and needle pieces.  | Wear safety glasses.   |
| Danger of crushing and suction: <ul style="list-style-type: none"> <li>◆ by the fabric take-down (main take-down, auxiliary take-down, comb take-down, belt take-down)</li> <li>◆ by the additional needle beds</li> </ul> | Do not reach in the gap between the needle beds.<br><br>Keep hands, face, loose clothing and other loose objects away: danger of crushing.<br><br>Do not reach into the area between the fabric take-down roller and the comb take-down. |

### 2.6.7 Safety Instructions for Lubrication, Cleaning and Maintenance

| Type of risks  | Measures   |
|--|--|
| Danger of crushing and cutting by the carriages, racking, the needle beds, the clamping and cutting devices. | <p>Switch off machine at main switch.</p> <p>Secure the machine against being switched on again.</p> <p>After working on the rear of the machine, re-fix the rear panels again.</p>  |
| Cleaning with compressed air   | <p>Observe the country-specific laws and regulations.</p> <p>Risk of soiling - do not blow directly into the motor.</p> <p>Recommendation:<br/>In order to avoid any dust being deposited on the inaccessible points of the machine, we recommend that the dust should be vacuum cleaned and the machine not to be cleaned by compressed air.</p> <p><b>Caution:</b><br/>Damage of needles!<br/>The spring-mounted needle latches will be damaged if the needles are blown out with compressed air.<br/>Always vacuum fluff and dust off the needles, never blow them out.</p> |
| Health hazard  | <p>When working with oil and grease, pay attention to the safety regulations (safety data sheets) applicable to the respective product!</p> <p>Observe the manufacturer's specifications (safety data sheet).</p>  |
| Environment pollution  | <p>Ensure that oil and grease is correctly disposed of in an environmentally responsible manner!</p> <p>Observe the country-specific laws and regulations.</p> <p>Observe the manufacturer's specifications (safety data sheet).</p>   |

## 2.6.8 Safety instructions for the repair

### Danger by mechanical parts

| Reason  | Measures   |
|---|--|
| Danger of injury by rotating or moving parts.   | <p>Do not reach into the running machine.</p> <p>Always stop the machine during an intervention.</p> <p>Switch off the machine during mounting activities and secure it against being switched on again. Lock the main switch.</p> <p>Wear safety glasses.</p>   |
| Injuries may be caused by pieces broken off from needles when the carriage and needles collide at damaged points.   | Wear safety glasses.   |
| Danger of burns by motors; the needle bed and parts of electric controls that can become hot.   | Wear protective gloves.  |
| Danger of crushing and cutting by the carriages, racking, the needle beds, the clamping and cutting devices and the additional needle beds.   | <p>Always stop the machine during an intervention.</p> <p>Move carriage step by step or at creep speed (see operating instructions).</p>   |
| <p>Danger of crushing and suction:</p> <ul style="list-style-type: none"> <li>◆ by the fabric take-down (main take-down, auxiliary take-down, comb take-down, belt take-down)</li> <li>◆ by the additional needle beds</li> </ul> | <p>Do not reach into the fabric take-down rollers nor into the belt take-down.</p> <p>Do not reach in the gap between the needle beds.</p> <p>Keep hands, face, loose clothing and other loose objects away: danger of crushing.</p> <p>Do not reach into the area between the fabric take-down roller and the comb take-down.</p> |
| Danger of injury in the case of mounting activities by pressure and tension springs (e.g. in the main take-down and in the engaging rod), which could have stored potential energy.   | <p>Releasing the springs before removing.</p> <p>Wear protective gear (e.g. safety glasses, gloves).</p>   |

Safety precautions regarding the machine's life phases

| Reason  | Measures  |
|---|---|
| Danger of injury in the case of mounting activities by sharp edges and protruding parts, when the protective devices are removed. | Wear protective gear (e.g. safety glasses, gloves). |

Danger by electrical energy

| Reason   | Measures  |
|--|---|
| Danger to life by electrical shock during work on the electrical assembly of the machine.  | <p>Work is to be done only by an electrician.</p> <p>Switch off machine.</p> <p>Remove building fuses.</p> <p>Secure the machine against being switched on again. Lock the main switch.</p>                                 |
| Danger to life by electric shock in case of electric faults like loose or defective connectors/plugs or braised or damaged cables. | <p>Deactivate the machine immediately.</p> <p>Remove building fuses.</p> <p>Secure the machine against being switched on again. Lock the main switch.</p> <p>Eliminate all faults that can be caused by an electrician.</p> |



Danger by operating materials









| Reason  | Measures  |
|---|---|
| Danger of chemical burns during contact with oil, grease and other chemical substances.                                   | <p>Wear protective gear (e.g. safety glasses, gloves).</p> <p>Observe the country-specific laws and regulations.</p> <p>Observe the manufacturer's specifications (safety data sheet).</p>  |
| Injuries by oil pressure in case of damaged lines of the central lubrication that are under a high oil pressure (30 bar). | <p>Deactivate the machine immediately.</p> <p>Secure the machine against being switched on again. Lock the main switch.</p> <p>Get the damaged lines replaced by a mechanic.</p> <p>Remove the outcoming oil immediately.</p>                       |
| Injuries by compressed air in case of damaged pipes of the fluff absorption that are under a high air pressure (3-6 bar). | <p>Deactivate the machine immediately.</p> <p>Secure the machine against being switched on again. Lock the main switch.</p> <p>Get the damaged lines replaced by a mechanic.</p>  |
| Danger of skidding if the oil, grease or other substances are blocked or if a leakage appears.                            | <p>Immediately mop these substances.</p> <p>Observe the country-specific laws and regulations.</p>  |
| Environment pollution is caused if the disposal of replaced parts and of consumables is not done professionally.          | <p>Ensure that all consumables and replaced parts are disposed of safely and with minimum environmental impact!</p> <p>Observe the country-specific laws and regulations.</p> <p>Observe the manufacturer's specifications (safety data sheet).</p> |

Other dangers

| Reason  | Measures  |
|---|---|
| Danger of damage by usage of unsuitable cleaning materials. | <p>Only cleaning materials that have been mentioned in the Operating Instructions for e.g. Alcohol are to be used. Do not use cleansing materials that can cause health hazards or are corrosive.</p> |

Safety precautions for the battery

The following safety instructions and protective measures must always be observed when handling the battery.

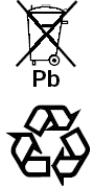
| Pictograph  | Safety precautions and protective measures  |
|---|---|
|    | Observe the safety precautions and protective measures.   |
|    | No smoking.<br>Do not allow open flame, glow or sparks in the vicinity of the battery because of explosion and fire hazards.  |
|    | Wear safety glasses as battery acid is highly corrosive.  |
|    | In case of acid splashes in the eye or on the skin flood with clear, cool running water. Afterwards, immediately see a doctor.<br>Wash the clothing with water.   |
|  | Explosion and fire hazards, avoid short circuits.<br>Charge the battery only in assembled state within the knitting machine.  |
|  | Battery acid is highly corrosive.<br>During normal operation the contact with the battery acid is excluded. In case of destruction of the housing, the battery acid can escape. Danger of acid burns.           |
|  | Batteries are sensitive to mechanical damages. Handle with care.  |
|  | Danger of short circuit.<br>The contacts of the battery are always under tension, therefore, do not place foreign objects or tools on the battery.  |
|  | Battery contains lead (Pb)<br>Do not dispose the battery as household waste.<br>Dispose the battery in an environmentally responsible manner.<br>Bring the battery to a collection facility for used batteries. |

**Mounting and checking  
protective devices**

After the repair work all the protective devices are to be remounted and fully functional.

- Close the rear panels of the machine.
- Close the lateral covers.
- Objects such as tools, bobbins etc. to be removed from the inside of the machine.
- Close the covers.
- Checking protective devices [☞ 101]

### 2.6.9 Safety instructions for dismantling work (dismantling)

Dismantling for a longer storage or for evacuation

| Type of risks   | Measures   |
|---|--|
| Danger to life because of electrical shock during work on the electrical assembly of the machine. | Get the machine disconnected from the mains supply by an electrician.  |
| Danger of damage to the machine during transport.   | Observe all technical data of the machine.<br>Country-specific regulations for the prevention of industrial accidents for the transport of heavy loads are to be observed. |

Dismantling and scrapping

| Type of risks   | Measures  |
|---|---|
| Danger to life because of electrical shock during work on the electrical assembly of the machine. | Get the machine disconnected from the mains supply by an electrician.   |
| Health hazard   | When working with oil and grease, pay attention to the safety regulations (safety data sheets) applicable to the respective product!<br>Observe the manufacturer's specifications (safety data sheet).  |
| Environment pollution during disposal.  | Ensure that oil and grease is correctly disposed of in an environmentally responsible manner!<br>Observe the country-specific laws and regulations.<br>Observe the manufacturer's specifications (safety data sheet).<br>Dispose of electric and electronic parts separately.<br>In the control unit there are accumulators. These contain lead.<br>Do not dispose of the accumulators together with the household waste, but deliver them at a battery collecting facility, to dispose of them in an environmentally responsible manner. |

■ Safety precautions for the battery [ 26]

### 3 Technical data of the machine

#### 3.1 Dimensions and weights

Machine dimensions

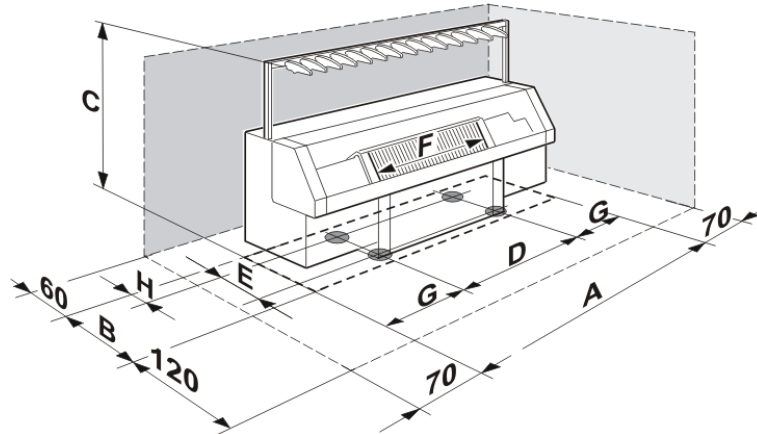

Machine dimensions (in cm)

- A Width
- B Depth
- C Height
- D, E Spacing of set screws
- F Nominal working width
- G Distance "machine foot - lateral panel"
- H Distance "machine foot - rear panel"

|            | A   | B   | C   | D   | E  | F   | G    | H    |
|------------|-----|-----|-----|-----|----|-----|------|------|
| CMS 933    | 510 | 106 | 205 | 270 | 56 | 244 | 120  | 33,5 |
| CMS 830 W  | 403 | 91  | 205 | 239 | 52 | 213 | 82   | 25   |
| CMS 830 S  | 403 | 91  | 205 | 239 | 52 | 218 | 82   | 25   |
| CMS 830 C  | 403 | 91  | 205 | 239 | 52 | 213 | 82   | 25   |
| CMS 830    | 403 | 91  | 205 | 239 | 52 | 213 | 82   | 25   |
| CMS 822    | 403 | 91  | 205 | 239 | 52 | 213 | 82   | 25   |
| CMS 730 T  | 355 | 91  | 205 | 209 | 52 | 183 | 73   | 25   |
| CMS 530    | 270 | 91  | 205 | 153 | 52 | 127 | 58,5 | 25   |
| CMS 530 W  | 270 | 91  | 205 | 153 | 52 | 127 | 58,5 | 25   |
| CMS 530 BW | 270 | 91  | 205 | 153 | 52 | 127 | 58,5 | 25   |
| CMS 520 C  | 270 | 91  | 205 | 153 | 52 | 127 | 58,5 | 25   |

Machine dimensions (in cm)

Dimensions and weights

CMS 202  
 CMS 303  
 CMS 330  
 CMS 330 W  
 CMS 502  
 CMS 503

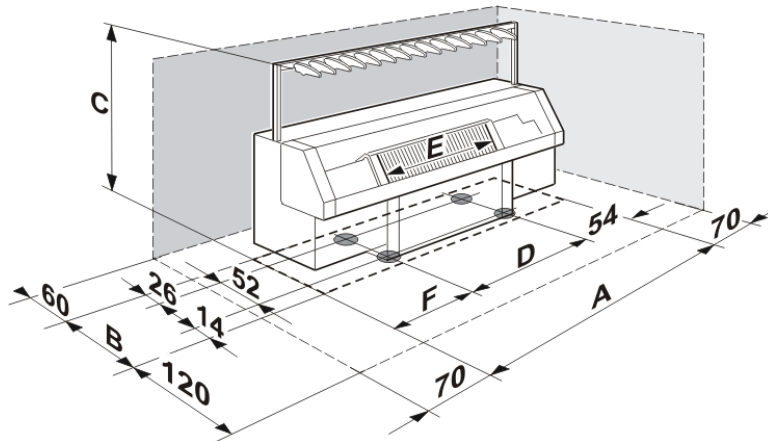

Machine dimensions (in cm)

- A Width
- B Depth
- C Height
- D Spacing of set screws
- E Nominal working width
- F Distance "machine foot - lateral panel"

|           | A   | B  | C   | D   | E    | F  |
|-----------|-----|----|-----|-----|------|----|
| CMS 202   | 184 | 92 | 205 | 82  | 61   | 43 |
| CMS 303   | 237 | 92 | 205 | 140 | 91,5 | 43 |
| CMS 330   | 237 | 92 | 205 | 140 | 91,5 | 43 |
| CMS 330 W | 237 | 92 | 205 | 140 | 91,5 | 43 |
| CMS 502   | 237 | 92 | 205 | 140 | 114  | 43 |
| CMS 503   | 243 | 92 | 205 | 140 | 114  | 50 |

Machine dimensions (in cm)

Weight and dynamic weight The back-and-forth movement of the carriage causes the dynamic loads ( $F_v$ ,  $F_h$ ) listed above to occur at the set screws.

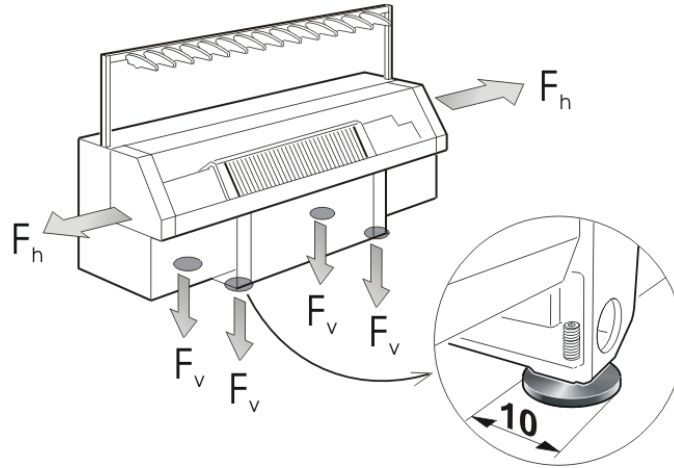

|            | Machine out of action | Machine in action              |                              |
|------------|-----------------------|--------------------------------|------------------------------|
|            | Weight (kg)           | $F_v$ (daN) [kg] per set screw | $F_h$ (daN) [kg] per machine |
| CMS 933    | 2060                  | 860                            | 170                          |
| CMS 830 W  | 1600                  | 710                            | 170                          |
| CMS 830 S  | 1640                  | 670                            | 130                          |
| CMS 830 C  | 1690                  | 710                            | 160                          |
| CMS 830    | 1600                  | 710                            | 170                          |
| CMS 822    | 1670                  | 710                            | 170                          |
| CMS 730 T  | 1510                  | 630                            | 160                          |
| CMS 530    | 1240                  | 540                            | 150                          |
| CMS 530 W  | 1240                  | 540                            | 150                          |
| CMS 530 BW | 1240                  | 540                            | 150                          |
| CMS 520 C  | 1250                  | 550                            | 160                          |
| CMS 503    | 1035                  | 470                            | 150                          |
| CMS 502    | 1025                  | 450                            | 130                          |
| CMS 330    | 1004                  | 460                            | 150                          |
| CMS 330 W  | 1004                  | 460                            | 150                          |
| CMS 303    | 885                   | 410                            | 150                          |
| CMS 202    | 736                   | 380                            | 130                          |

Weight and dynamic weight (without special attachments, without yarn)

### 3.2 Electrical data

| Electrical data                                 | Values  |   |  |
|---|---|---|--|
| Supply voltage                                  | 230 / 400 V ±10 %<br>50 or 60 Hz  |   |  |
| Phase number                                    | 1 (2)   |   |  |
| Rated current                                   | 10 A  |   |  |
| Protection of the mains to the knitting machine | 16 A slow-blow  |   |  |
| Mains supply, cross-section                     | <br>3x ≥ 1,5 mm <sup>2</sup>  | <br>4x ≥ 1,5 mm <sup>2</sup>  | <br>5x ≥ 1,5 mm <sup>2</sup>   |
|   | CMS 202<br>CMS 303<br>CMS 330<br>CMS 330 W<br>CMS 502<br>CMS 503<br>CMS 520 C<br>CMS 530<br>CMS 530 B<br>CMS 530 BW   | CMS 330<br>CMS 330 W<br>CMS 520 C<br>CMS 530<br>CMS 530 B<br>CMS 530 BW   | CMS 330<br>CMS 330 W<br>CMS 520 C<br>CMS 530<br>CMS 530 B<br>CMS 530 BW<br>CMS 730 T<br>CMS 822<br>CMS 830<br>CMS 830 W<br>CMS 830 C<br>CMS 830 S<br>CMS 933 |
| Connection value                                | CMS 202: 1.7 kW<br>CMS 303: 2.3 kW<br>CMS 330: 2.3 kW<br>CMS 330 W: 2.3 kW<br>CMS 502: 1.7 kW<br>CMS 503: 2.3 kW<br>CMS 520 C: 2.0 kW<br>CMS 530: 2.3 kW<br>CMS 530 W: 2.3 kW | CMS 530 BW: 2.3 kW<br>CMS 730 T: 2.3 kW<br>CMS 822: 2.6 kW<br>CMS 830: 2.3 kW<br>CMS 830 C: 2.3 kW<br>CMS 830 S: 2.7 kW<br>CMS 830 W: 2.3 kW<br>CMS 933: 3.0 kW |  |

Connection data of the knitting machine

Before connecting the machine, check the mains voltage available on site.

It is generally not admissible to connect electrical or electronic components of other makes to the machine's internal wiring. A guarantee for a faultless function of the machine cannot be ensured in those cases.



If the knitting machine is operated with a generator, make sure that the voltage supplied by the generator meets the requirements of the EN 60204-1, Parag. 4.3.1.

In case of queries, please call the Stoll Helpline.

### 3.3 Gauge ranges

| Gauge          | Area | Needle number<br>(nominal width) |                |                  |                 |                 |                 |                 |                 |                 |
|----------------|------|----------------------------------|----------------|------------------|-----------------|-----------------|-----------------|-----------------|-----------------|-----------------|
|                |      | 61 cm<br>(24")                   | 76 cm<br>(30") | 91,5 cm<br>(36") | 114 cm<br>(45") | 127 cm<br>(50") | 183 cm<br>(72") | 213 cm<br>(84") | 218 cm<br>(86") | 244 cm<br>(96") |
| E 3<br>E 1,5.2 | A    |                                  |                |                  |                 | 149             |                 |                 |                 |                 |
| E 3.5          |      |                                  |                |                  |                 | 174             |                 |                 |                 |                 |
| E 4<br>E 2.2   |      |                                  |                |                  |                 | 199             |                 |                 |                 |                 |
| E 5<br>E 2,5.2 | B    |                                  |                |                  | 224             | 249             | 359             | 419             |                 | 479             |
| E 7<br>E 3,5.2 |      |                                  |                |                  | 314             | 349             | 503             | 587             | 601             | 671             |
| E 8            |      |                                  |                |                  | 359             | 399             | 575             | 671             |                 | 767             |
| E 5.2          |      |                                  |                |                  | 449             | 499             | 719             | 839             |                 | 959             |
| E 10           | C    | 239                              |                | 359              | 449             | 499             | 719             | 839             |                 | 959             |
| E 12<br>E 6.2  |      | 287                              |                | 431              | 539             | 599             | 863             | 1007            |                 | 1151            |
| E 14<br>E 7.2  |      | 335                              | 419            | 503              | 629             | 699             | 1007            | 1175            | 1203            | 1343            |
| E 16<br>E 8.2  |      | 383                              |                | 575              | 719             | 799             | 1151            | 1343            |                 | 1535            |
| E 18<br>E 9.2  |      | 431                              |                | 647              | 809             | 899             | 1295            |                 | 1548            | 1727            |
| E 20<br>E 10.2 |      |                                  |                | 719              |                 | 999             |                 | 1679            |                 |                 |

Number of needles per needle bed



The conversion into another gauge depends on the machine type and the gauge range (A, B or C). Please demand our offer for your machine.

### 3.4 Operating conditions

- Set the machine on a level, firm surface in a building
- Do not set the machine in an area endangered by explosions or underground
- Ambient temperature 59 °F to 113 °F (+15 °C to +45 °C)
- Relative humidity:
  - min. 50 %
  - max. 80 %
  - not condensed

When yarns are being processed, electrostatic charges can be produced if the relative humidity is not at least 50 %

In the case of deviating operating conditions please contact Stoll helpline.

### 3.5 Storage conditions

If the knitting machine is to be stored for a longer period of time the following tasks must be carried out:

1. Clean the knitting machine thoroughly.
2. Lubricate knitting machine.
3. When the knitting machine is transported to another place, the transport locks must be applied.
4. All bare metals must be sprayed with an anticorrosion agent (e.g. WD-40).
5. Cover the area yarn carrier rods -needle beds with gas paper/anti-rust paper.
6. Cover the knitting machine with a protective foil.
7. Store the knitting machine in a dry place within a building.

---

**i** Storage temperature -15 °C to +60 °C.  
Protect the machine carefully from corrosion especially against sea air.

In case of a longer storage check the condition of the machine regularly and spray the bare metals with an anticorrosion agent if necessary.

---

- Safety instructions for the transport [▢ 16]
- Safety instructions for dismantling work (dismantling) [▢ 28]

### 3.6 Noise emissions

The measuring has been performed on a representative basis for the series CMS 5xx HP on a CMS 530 HP E7.2. The machines of the CMS 5xx HP series emit a sound pressure level which is not higher than the specified values under comparable conditions.

Applied standards:

- ISO/CD 9902 "Textile machine regulations for noise emissions"
- ISO/CD 9902-1 and ISO/CD 9902-6.

| Level specifications in dB(A) | mean sound pressure level LpA | Uncertainty KpA |
|-------------------------------|-------------------------------|-----------------|
| CMS 530 HP                    | 74,7                          | 4               |

Noise emissions

## 4 Main components of the knitting machine

### 4.1 Front side

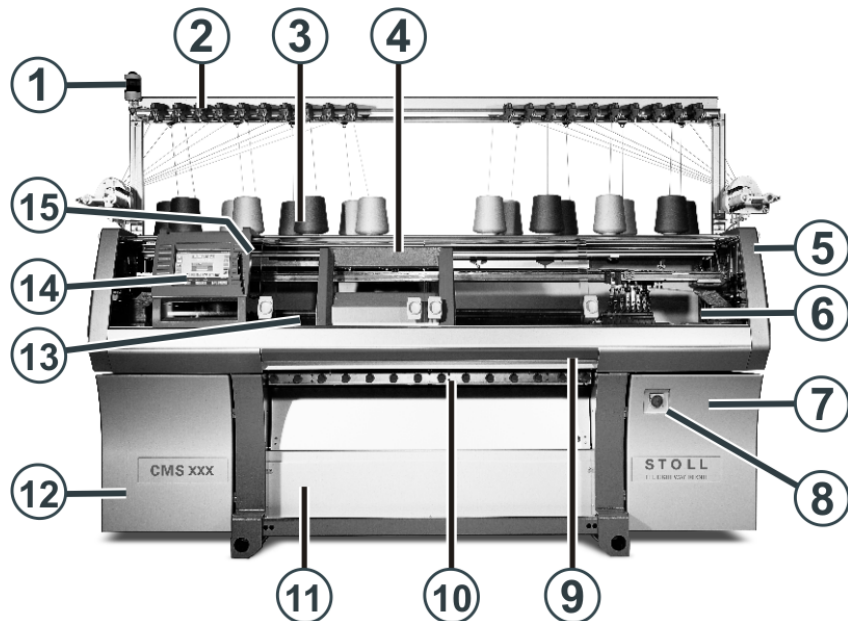

Front view of the knitting machine

| No. | Designation                           | No. | Designation  |
|-----|---------------------------------------|-----|--|
| 1   | Signal light (green, yellow)          | 9   | Engaging rod (red)   |
| 2   | Yarn control units                    | 10  | Fabric take-down (main take-down, auxiliary take-down, comb take-down, belt take-down) |
| 3   | Bobbin board (with bobbin)            | 11  | Fabric collection chamber  |
| 4   | Carriage                              | 12  | Left control cabinet   |
| 5   | Safety door (left, right)             | 13  | Needle and additional beds (front)   |
| 6   | Covers (over carriage and needle bed) | 14  | Touch screen   |
| 7   | Right control cabinet                 | 15  | USB port   |
| 8   | Main switch and emergency stop switch |     |  |

Front side

Inner view

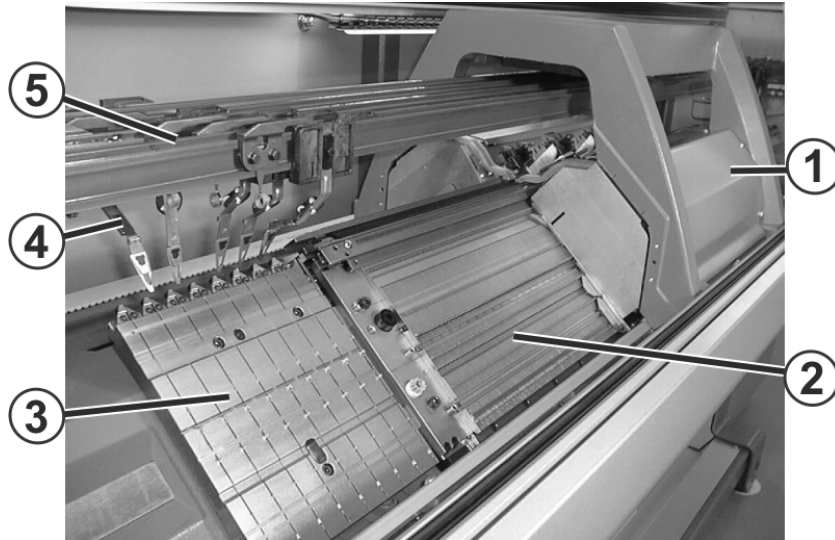

Inner view of the knitting machine

| No. | Designation                   | No. | Designation      |
|-----|-------------------------------|-----|------------------|
| 1   | Carriage                      | 4   | Yarn Carrier     |
| 2   | Front needle bed              | 5   | Yarn carrier rod |
| 3   | Left clamping and cutting bed |     |                  |

## 4.2 Lateral view (right)

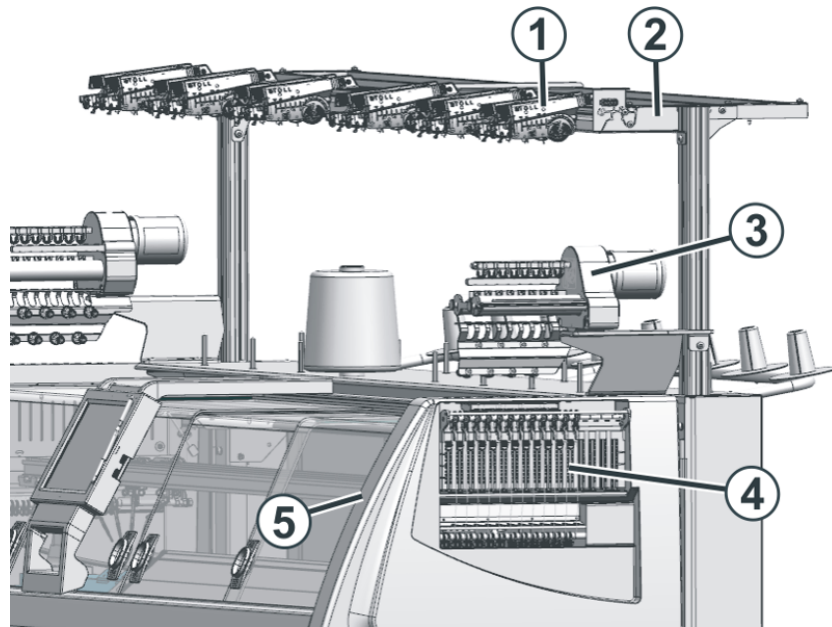

Right lateral view

| No. | Designation         | No. | Designation            |
|-----|---------------------|-----|------------------------|
| 1   | Yarn Control Unit   | 4   | Lateral yarn tensioner |
| 2   | Yarn guide device   | 5   | Lateral safety door    |
| 3   | Friction feed wheel |     |                        |

### 4.3 Rear side

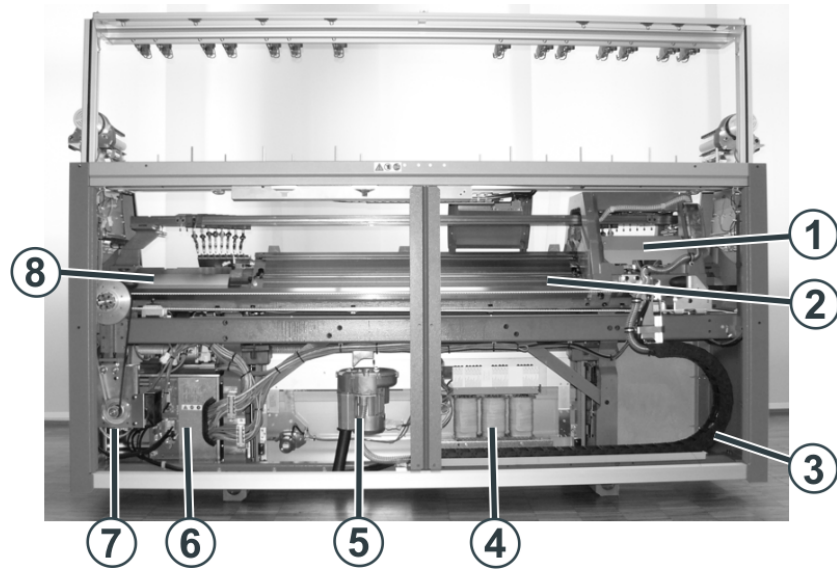

Rear side (without rear panel segments)

| No. | Designation                   | No. | Designation               |
|-----|-------------------------------|-----|---------------------------|
| 1   | Carriage                      | 5   | Fluff absorption          |
| 2   | Rear needle bed               | 6   | Control unit on the right |
| 3   | Trailing cable (energy chain) | 7   | Main Drive                |
| 4   | Transformer (Fuses)           | 8   | Racking device            |



## 5 Security relevant operating elements

### 5.1 Main switch



Main switch

The main switch (1) is located on the front of the machine above the right control unit.

In position "1 - On" the main switch is switched on, in position "0 - Off" it is switched off.

**Shutdown process** When the main switch is turned from "1" to "0", the machine is immediately switched off. Dangerous movements are immediately stopped. However, the machine data are not lost, as they are saved with a battery. This takes approx. 60 seconds. In the process, messages appear on the touch screen. Once the process is complete, the touch screen becomes dark.

Even with the main switch switched off, the mains supply up to the main switch still carries current with extremely high voltage. The mains supply must be disconnected and secured against being switched on again before working on the main switch unit.

**Emergency-stop** The main switch is also the emergency-stop switch.

The main switch has to be locked during maintenance and service work. This prevents the main switch from being switched on accidentally.

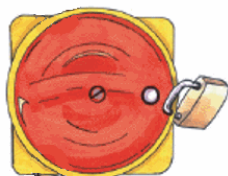

## 5.2 Engaging Rod

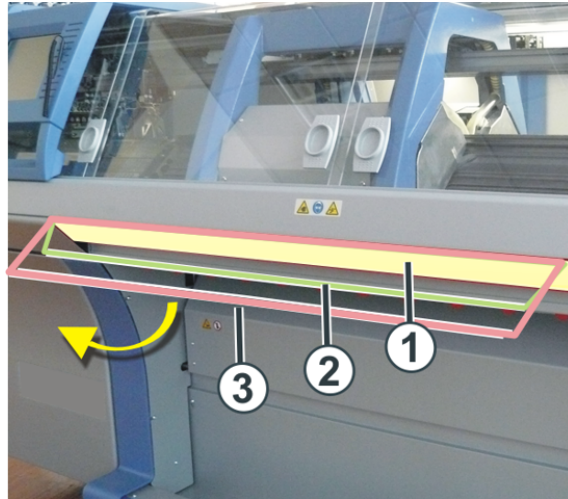

Engaging Rod

- 1 Carriage stopped
- 2 reduced speed
- 3 normal speed

The carriage assembly, and therefore also knitting, is started and stopped with the engaging rod. The engaging rod can be moved into three positions.

## 6 Optical and acoustic signal elements

The knitting machine control constantly controls the yarn, the fabric, all movable parts of machine, the motors and the electronic components. If an error occurs, the machine stops. The signal light glows yellow, a pictogram appears on the touch screen and a horn goes off.

### 6.1 Signal light



Signal light

The signal light (1) displays the operating status of the knitting machine. Depending on the machine type, the signal light is mounted either on the left or on the right machine side.









| Color           | Status of the knitting machine  |
|-----------------|---|
| green           | Knitting machine is producing   |
| green (flashes) | Knitting machine is stopped with engaging rod   |
| Yellow          | Knitting machine is not producing, as an error has occurred during knitting   |
| green, yellow   | Both lamps light up during the shutdown process. Duration is approximately 60 seconds - from switching off main switch until machine is completely shut down. |
| off             | Main switch is switched off   |

Signal light colors

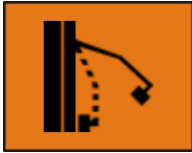











## 6.2 Touch screen

The most common error causes are shown in the pictographs on the touch screen.

If an error occurs, one pictograph appears (on a yellow background), and in the case of several errors the corresponding pictographs appear consecutively. Errors which occur seldom (e. g. hardware errors) are shown with a common pictograph.

| Pictographs   |  |   |
|---|--|---|
|    |    |    |
| Cover on the left   | Cover on the right   | Cover   |
|   |   |   |
| Yarn tensioner on the left  | Yarn tensioner on the right  | Yarn Control Unit   |
|  |  |  |
| Front shock stop motion   | Rear shock stop motion   | Carriages   |
|  |  |  |
| Front Additional Bed  | Rear Additional Bed  | Take-down (Machine with comb take-down)   |
|  |  |  |
| Auxiliary Take-down   | Comb take-down   | Belt Take-Down  |

Pictographs for the display of stop motions

| Pictographs   |  |   |
|---|--|---|
|    |    |    |
| Winding plate   | Take-down (Machine without comb take-down)   | Oiling or Greasing  |
|    |    |    |
| Needle stop left  | Needle stop center   | Needle stop right   |
|   |   |   |
| Comb is in the needle bed   | Collision risk of comb with main take-down   | Collision risk of comb with auxiliary take-down                                       |
|  |  |  |
| Comb light barrier interrupted  | Piece Counter  | miscellaneous causes of stop motion   |

Pictographs for the display of stop motions

### 6.3 Horn

An alarm signal is produced in the following situations:

- if the machine stops because of an error
- approx. 60 seconds after this the main switch gets rotated to "0"

---

**i** The alarm signal can be switched on and off (standard setting = off).

---

## 6.4 Lamp on the yarn control device



Lamp on the yarn control device

In the case of a yarn breakage or yarn end, the yarn break control of the yarn control device switches off the knitting machine. The error is displayed by the LED on the yarn control device, the signal light glows yellow and a message appears on the touch screen.

## 7 Assembly and setting up

### 7.1 Preparing assembly

#### 7.1.1 Preparing installation location

Installation location The installation location of the knitting machine must fulfill the following conditions:

- flat, firm surface in a building
- sufficient space between the knitting machines for
  - Operating the machine
  - Removing the fabrics from the machine
- do not put up the machine underground

#### 7.1.2 Having tools and aids ready

The knitting machine is delivered packed in one of the following ways:

- on a transport base packed in film
- on a transport base packed in a crate

The following tools and aids are required for all types of packing:

- Accessories for knitting machine
  - Washers for machine feet
  - Setscrews for aligning the machine
  - Square spanner for opening the rear machine panel.
- Tool
- Spirit level

### 7.1.3 Transporting machine to installation location

|   |  |
|---|--|
|  | <b>DANGER</b>  |
|   | <p><b>Heavy knitting machine!</b></p> <p>Danger of injury for persons and damage of the knitting machine.</p> <ul style="list-style-type: none"><li>→ Country-specific regulations for the prevention of industrial accidents for the transport of heavy loads are to be observed.</li><li>→ Use only appropriate means of transport with sufficient load capacity for transporting and installing the knitting machine (e.g. fork lift).</li><li>→ The relevant country-specific laws and regulations are to be observed when transporting with a ground conveyor (e.g. fork lift).</li><li>→ Ground conveyor: observe the safety instructions of the manufacturer.</li><li>→ Transport the machine always with the utmost caution and care.</li><li>→ All transport locks are to be attached to the machine.</li></ul> |

- Transport the knitting machine to the installation location in its packing and remove the packing there.

### 7.1.4 Unpacking knitting machine

1. When delivered in a crate: Remove crate lid and side walls.
2. Remove boxes with accessory parts from the fabric collection chamber.



## 7.2 Assembling machine

### 7.2.1 Putting up knitting machine

Lift the knitting machine with a ground conveyor (e.g. fork lift) and transport it.

In this case the following things have to be taken care of:

- The position of the centre of gravity is indicated on the front crosshead (carriage in left transport position).
- Both the lifting arms of the ground conveyor should be long enough so that the front and the rear crosshead can be lifted.
- Lift and set the machine carefully. Danger of damage if it hits the floor very hard.



Lift the machine only on both the machine feet or on the crossheads.

Setting up knitting machine:

1. Remove the screwing of the knitting machine to the transport base.

| <b>DANGER</b> |   |
|---------------|---|
|               | <p><b>Heavy knitting machine!</b></p> <p>Danger of injury for persons and damage of the knitting machine.</p> <ul style="list-style-type: none"> <li>→ Country-specific regulations for the prevention of industrial accidents for the transport of heavy loads are to be observed.</li> <li>→ Use only appropriate means of transport with sufficient load capacity for transporting and installing the knitting machine (e.g. fork lift).</li> <li>→ The relevant country-specific laws and regulations are to be observed when transporting with a ground conveyor (e.g. fork lift).</li> <li>→ Ground conveyor: observe the safety instructions of the manufacturer.</li> <li>→ Transport the machine always with the utmost caution and care.</li> <li>→ All transport locks are to be attached to the machine.</li> </ul> |

2. Lift the knitting machine with a fork lift from the transport surface.
3. Bring the knitting machine to the site of installation.

4. Lay Washers (1) from the accessories under the knitting machine foot. Place the washers in such a manner that the cavity comes exactly under the grub screw (2).

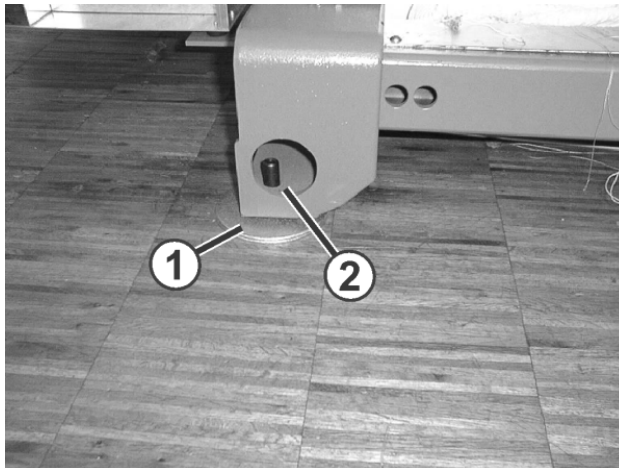

5. Setting knitting machine on the floor
6. Remove wood pieces, adhesive strips, packing film and paper.
7. Remove the screws (5). In the case of the CMS 502, loosen the screws (5).

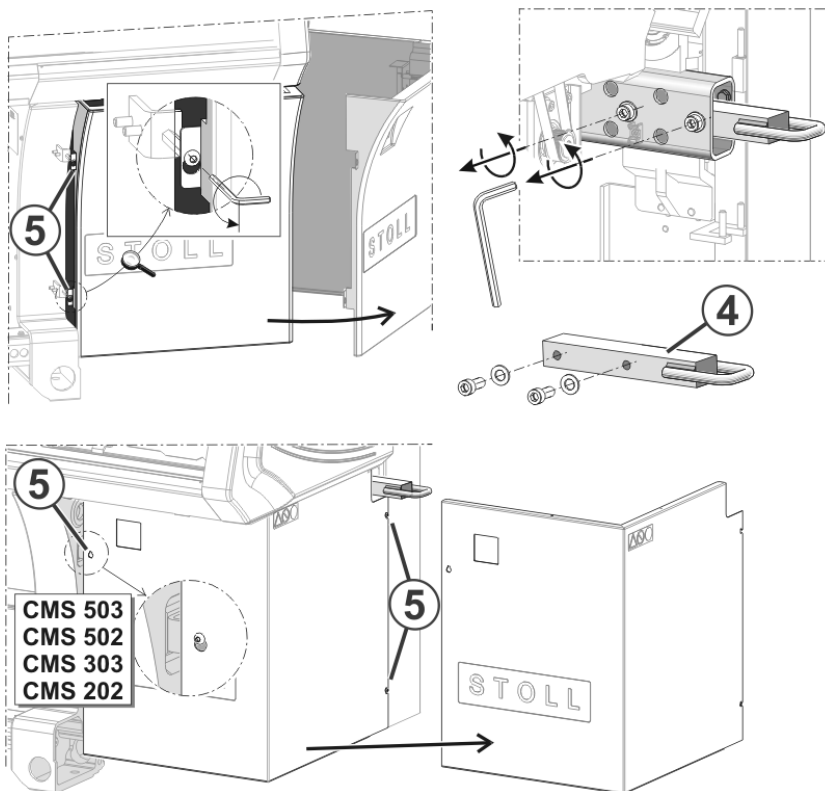

8. Swivel the cover of the control unit outwards. In the case of the CMS 502, remove the cover.
9. Remove the transport flap (4).



In the case of the CMS 502, the steps 10 to 13 are not necessary.

---

10. Remove the safety nut (6). It does not move easily since the safety nut is self-locking.

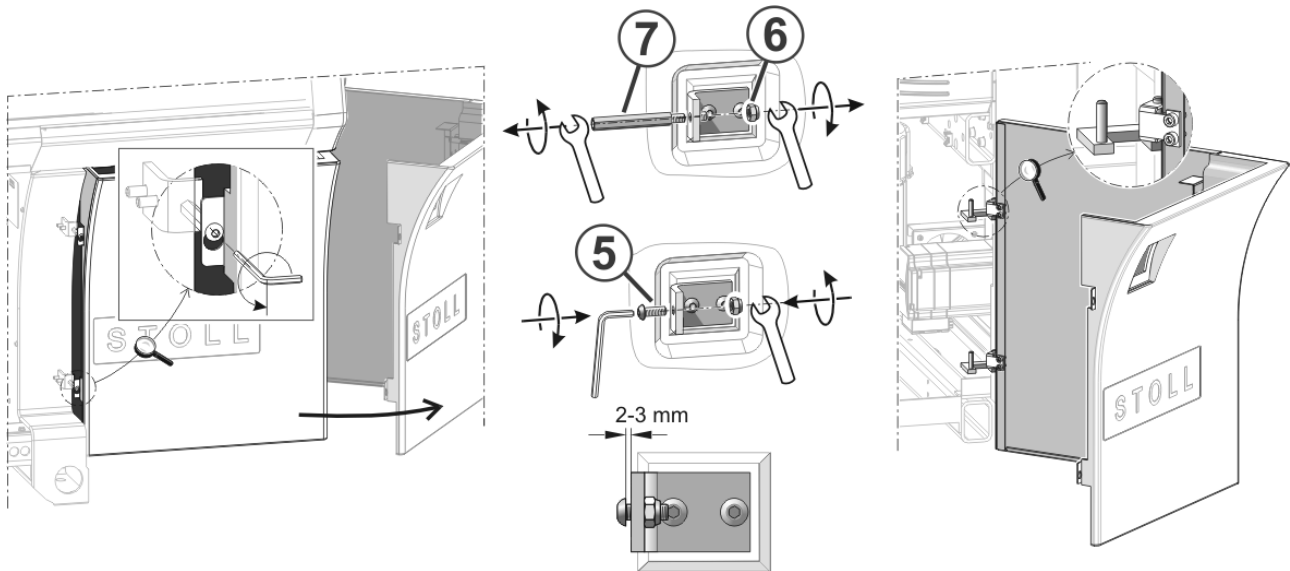

11. Unscrew the distance bolt (7).
12. Screw the screw (5) into the holder until it protrudes at the rear of the holder and the safety nut can completely be screwed-on.
13. Hook-in the control unit cover in the rear position.
14. Close the cover. Ensure that the cover engages in the screws (5).
15. Tighten the screws (5); this way the cover is secured.
16. Repeat the steps 7 to 15 on the other machine side.
17. Remove all transport locks.

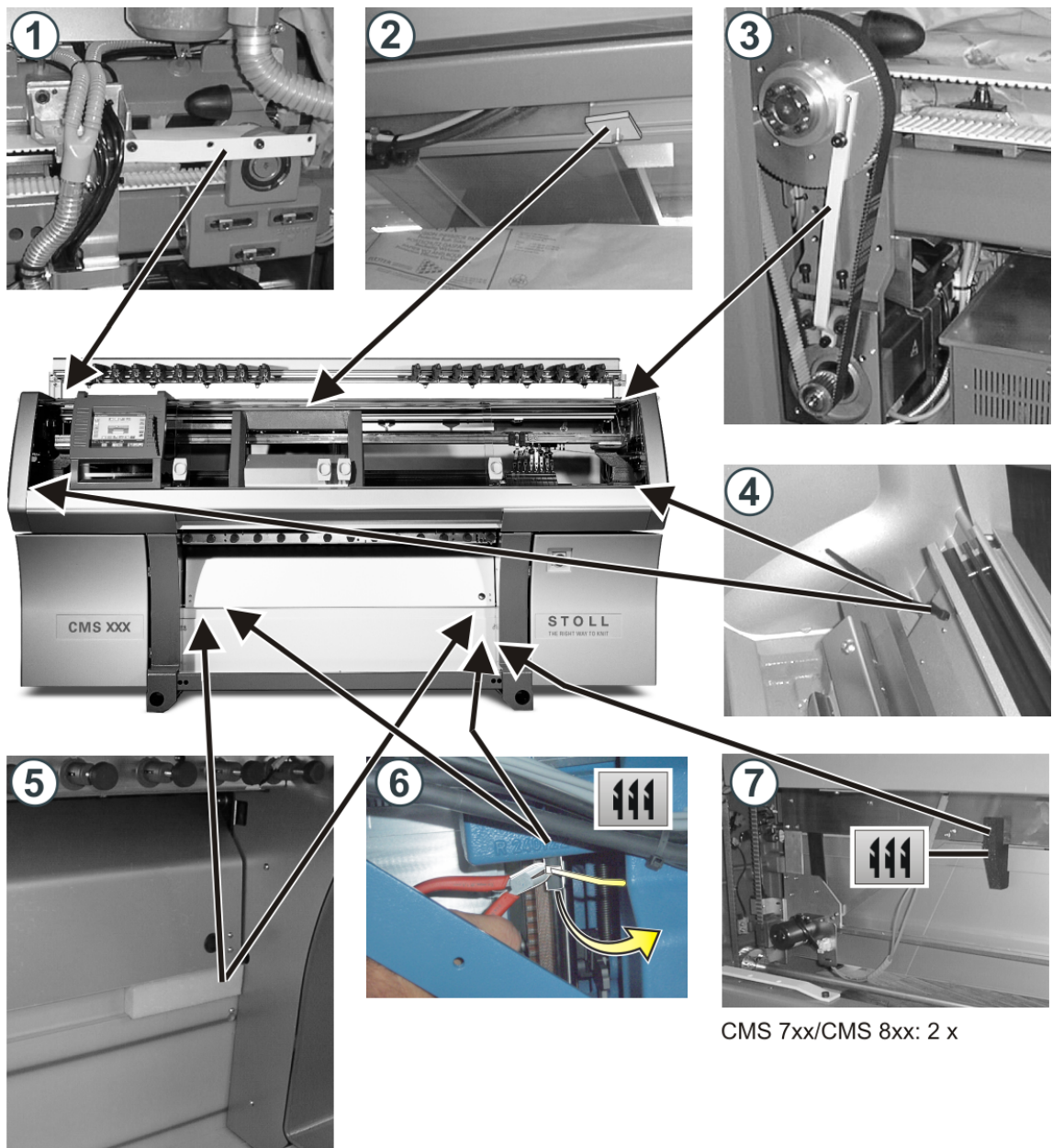

CMS 7xx/CMS 8xx: 2 x

Fixing spots for transport locks



Transport lock for:

- |                        |   |
|------------------------|---|
| 1 Carriages            | 5 Cover at comb take-down                           |
| 2 Touch screen         | 6 Comb take-down                                    |
| 3 Drive                | 7 Comb take-down (2 pieces for CMS 7xx and CMS 8xx) |
| 4 Left and right cover |   |

**i** Preserve the transport locks.

### 7.2.2 Connecting knitting machine, overview

Depending on the machine type, the knitting machine is connected differently.

| Machine Type  | Main switch   | Mains voltage | Chapter  |
|---|---|---------------|--|
| CMS 530<br>CMS 530 W<br>CMS 530 BW<br>CMS 520 C<br>CMS 330<br>CMS 330 W           |    | 230 V         | Connecting the knitting machine (mains voltage 230 V) [ 54]                        |
|   |   | 400 V         | Connecting the knitting machine (mains voltage 400 V) [ 60]                        |
|   |   | 230 V / 120 V | Connecting the knitting machine (mains voltage 230 V / 120 V, "Phase-Phase") [ 66] |
| CMS 933<br>CMS 822<br>CMS 730 T<br>CMS 830<br>CMS 830 C<br>CMS 830 S<br>CMS 830 W |   | 400 V         | Connecting the knitting machine (mains voltage 400 V, 3 phases) [ 72]              |
| CMS 503<br>CMS 502<br>CMS 303<br>CMS 202  |  | 400 V / 230 V | Connecting the knitting machine (mains voltage 400 V / 230 V) [ 77]                |
|   |   | 230 V / 120 V | Connecting the knitting machine (mains voltage 230 V / 120 V, "Phase-Phase") [ 81] |

### 7.2.3 Connecting the knitting machine (mains voltage 230 V)

|                                |   |
|--------------------------------|---|
| This description is valid for: |   |
| Mains voltage                  | 230 V   |
| Countries                      | e.g. Europe, China, Hong Kong   |
| Machine Type                   | CMS 530<br>CMS 530 W<br>CMS 530 BW<br>CMS 520 C<br>CMS 330<br>CMS 330 W |

|   |   |
|---|---|
|  | <b>DANGER</b>   |
|   | <p><b>Life-threatening high voltage!</b></p> <p>Electrical shock may cause death or serious injuries.</p> <p>→ Deenergize on-site mains supply.</p> |

The knitting machine is connected in the following steps:

- Connecting the mains supply
- Adapting the fluff absorption to the mains frequency

Authorized personnel

The knitting machine must be connected by an electrician. Country-specific laws and regulations are to be followed.

Operating the knitting machine with a generator

If the knitting machine is operated with a generator, make sure that the voltage supplied by the generator meets the requirements of the EN 60204-1, Parag. 4.3.1.

In case of queries, please call the Stoll Helpline.

Connect mains supply

**DANGER****Life-threatening high voltage!**

Electrical shock may cause death or serious injuries.

- The knitting machine must be connected by an electrician.
- Country-specific laws and regulations are to be followed.

Lead the mains supply cable to the right control cabinet:

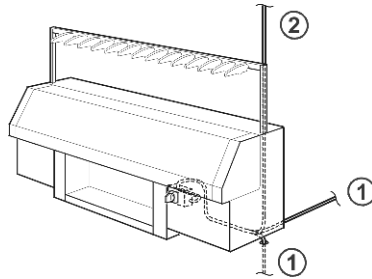

- via the floor (1)
- coming from the ceiling (2) through the right support of the yarn guide device

How to connect the mains supply:

|   |  |
|---|--|
|  | <b>DANGER</b>  |
|   | <b>Life-threatening high voltage!</b><br>Electrical shock may cause death or serious injuries.<br>→ Deenergize on-site mains supply. |

- ✓ The main switch is switched off ("0")
- ✓ The mains supply to the machine is unplugged (currentless)

1. Open the cover at the right control cabinet.
2. Press the release button (1) and unplug the plug (2).

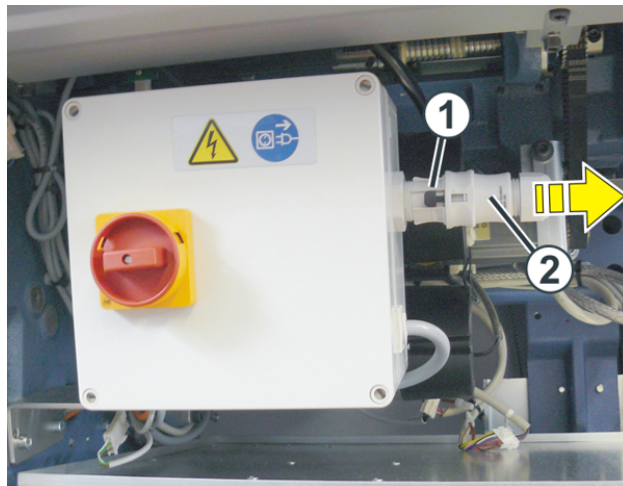





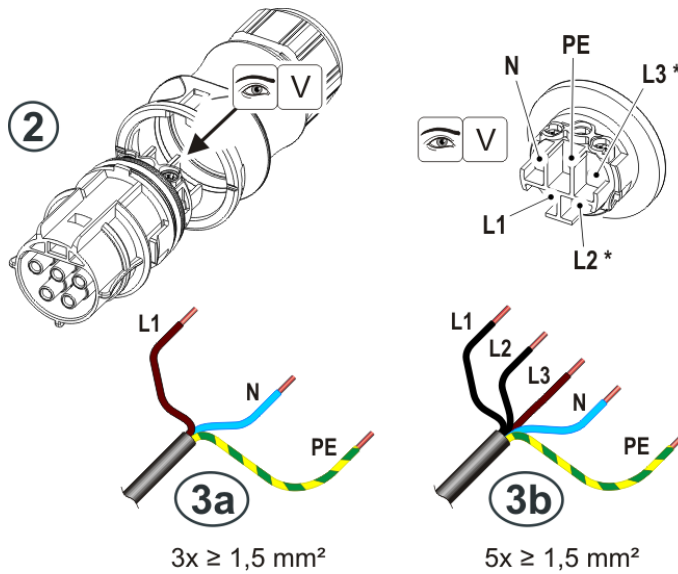

3. Open the plug (2) and connect to the mains supply (3a) or (3b).



|  | Mains supply (3a) | Mains supply (3b)  |          |          | Example for mains symmetry |
|--|-------------------|--------------------|----------|----------|----------------------------|
|  |                   | Connection variant |          |          |                            |
| Plug (2)   |                   | <b>A</b>           | <b>B</b> | <b>C</b> |                            |
| L1   | L1                | L1                 | L2       | L3       |                            |
| L2 *   | -                 | L2 **              | L3 **    | L1 **    |                            |
| L3 *   | -                 | L3 **              | L1 **    | L2 **    |                            |
| N  | N                 | N                  | N        | N        |                            |
| PE   | PE                | PE                 | PE       | PE       |                            |
| <p>* L2 and L3 are not used internally in the machine. Therefore, the phases of the operational mains supply must be distributed evenly on L1, L2 and L3.</p> <p>** if available</p> |                   |                    |          |          |                            |

4. Make sure that the operational mains supply is loaded evenly (mains symmetry). You will find the connection variants (A, B, C) in the above table.

|   |  |
|---|--|
|  | <b>WARNING</b>   |
|   | <p><b>Potential equalization missing!</b></p> <p>Serious failures or faults can be caused in the machine and the electronic circuit if the terminal  (PE) is not connected.</p> <p>→ Always connect terminal .</p> |

5. The terminal  for the protective conductor "PE" must be connected.
6. Close the plug (2) and connect it to the main switch.
7. Open the main switch.  
For this, loosen the 4 screws and remove the cover of the main switch.

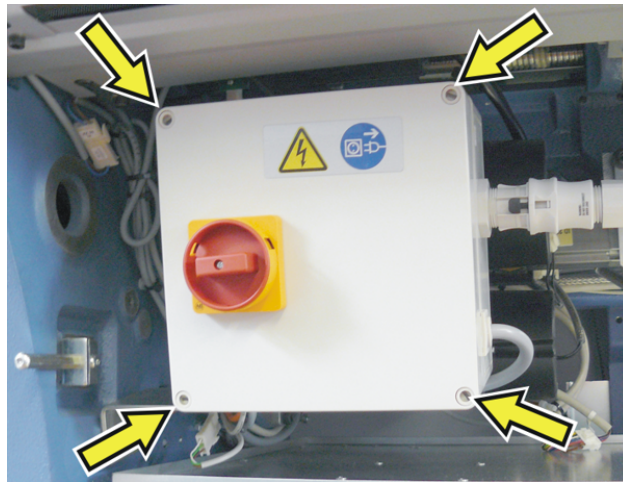

8. Connect the plug (4) on the left side.

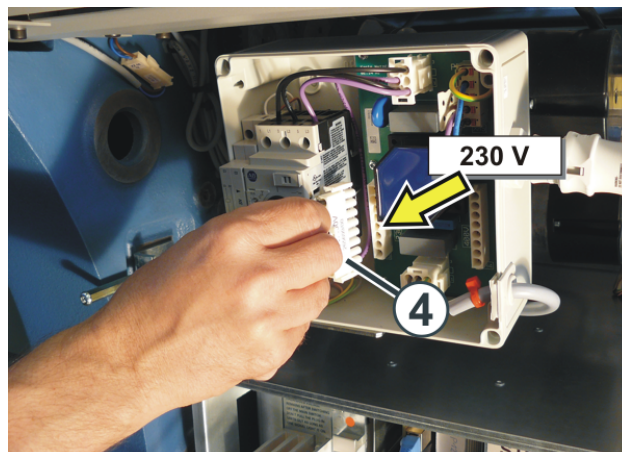

9. Close the main switch.
10. Close the cover at the right control cabinet again.

Adapting fluff absorption to  
mains frequency

Depending on the mains frequency (50 Hz or 60 Hz), the fluff absorption operates with or without sealing plugs.

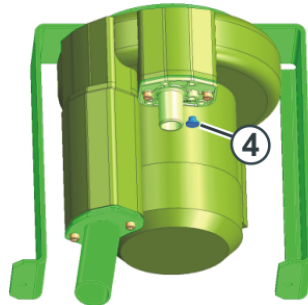

Adapting fluff absorption

---

**i**

The fluff absorption can be damaged if the mains frequency is not adapted!

The fluff absorption is overloaded if it is not adapted to the mains frequency.

-> Adapt the fluff absorption to the mains frequency.

---

1. Open the rear panel segments.
2. Check the sealing plugs (4) of the suction unit.
3. At Mains frequency 50 Hz: Insert sealing plug.  
- or -  
At Mains frequency 60 Hz: Remove sealing plug.
4. Close the rear panel segments.

## 7.2.4 Connecting the knitting machine (mains voltage 400 V)

|                                |   |
|--------------------------------|---|
| This description is valid for: |   |
| Mains voltage                  | 400 V   |
| Countries                      | e.g. Europe, China, Hong Kong   |
| Machine Type                   | CMS 530<br>CMS 530 W<br>CMS 530 BW<br>CMS 520 C<br>CMS 330<br>CMS 330 W |

|   |   |
|---|---|
|  | DANGER  |
|   | <p><b>Life-threatening high voltage!</b><br/>Electrical shock may cause death or serious injuries.<br/>→ Deenergize on-site mains supply.</p> |

The knitting machine is connected in the following steps:

- Connecting the mains supply
- Adapting the fluff absorption to the mains frequency

Authorized personnel

The knitting machine must be connected by an electrician. Country-specific laws and regulations are to be followed.

Operating the knitting machine with a generator

If the knitting machine is operated with a generator, make sure that the voltage supplied by the generator meets the requirements of the EN 60204-1, Parag. 4.3.1.

In case of queries, please call the Stoll Helpline.

Connect mains supply

**DANGER****Life-threatening high voltage!**

Electrical shock may cause death or serious injuries.

- The knitting machine must be connected by an electrician.
- Country-specific laws and regulations are to be followed.

Lead the mains supply cable to the right control cabinet:

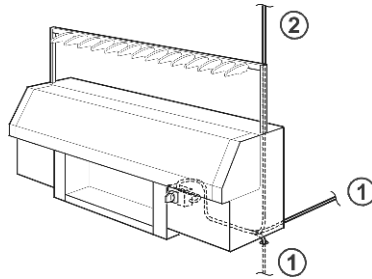

- via the floor (1)
- coming from the ceiling (2) through the right support of the yarn guide device

How to connect the mains supply:

|   |  |
|---|--|
|  | <b>DANGER</b>  |
|   | <b>Life-threatening high voltage!</b><br>Electrical shock may cause death or serious injuries.<br>→ Deenergize on-site mains supply. |

- ✓ The main switch is switched off ("0")
- ✓ The mains supply to the machine is unplugged (currentless)

1. Open the cover at the right control cabinet.
2. Press the release button (1) and unplug the plug (2).

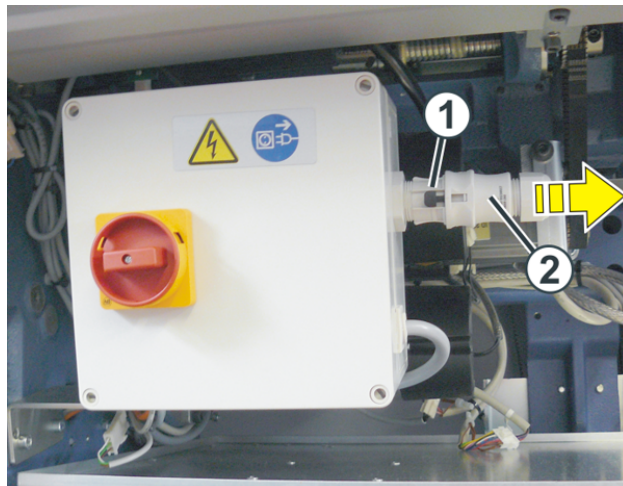

3. Open the plug (2) and connect to the mains supply (3).

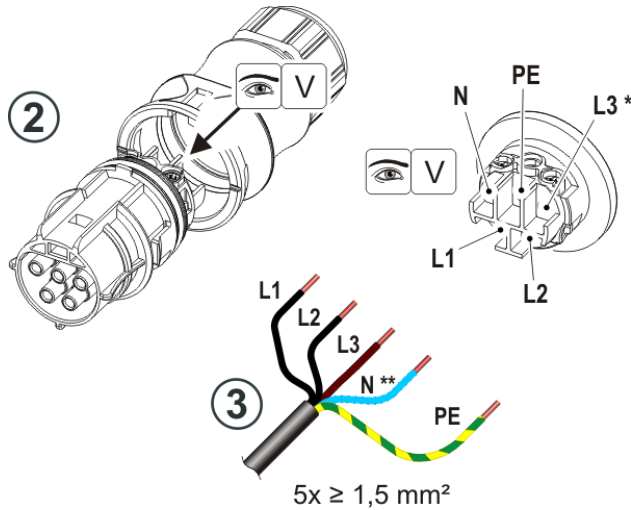

|  | Mains supply (3)   |          |          | Example for mains symmetry |
|--|--------------------|----------|----------|----------------------------|
|  | Connection variant |          |          |                            |
| Plug (2)   | <b>A</b>           | <b>B</b> | <b>C</b> |                            |
| L1   | L1                 | L2       | L3       |                            |
| L2   | L2                 | L3       | L1       |                            |
| L3 *   | L3 **              | L1 **    | L2 **    |                            |
| N  | N **               | N **     | N **     |                            |
| PE   | PE                 | PE       | PE       |                            |
| <p>* L3 is not used internally in the machine. Therefore, the phases in the plug (2) must be distributed evenly on L1 and L2.</p> <p>** if available</p> |                    |          |          |                            |

4. Make sure that the operational mains supply is loaded evenly (mains symmetry). You will find the connection variants (A, B, C) in the above table.

**WARNING****Potential equalization missing!**

Serious failures or faults can be caused in the machine and the electronic circuit if the terminal  $\oplus$  (PE) is not connected.

→ Always connect terminal  $\oplus$ .

5. The terminal  $\oplus$  for the protective conductor "PE" must be connected.
6. Close the plug (2) and connect it to the main switch.
7. Open the main switch.  
For this, loosen the 4 screws and remove the cover of the main switch.

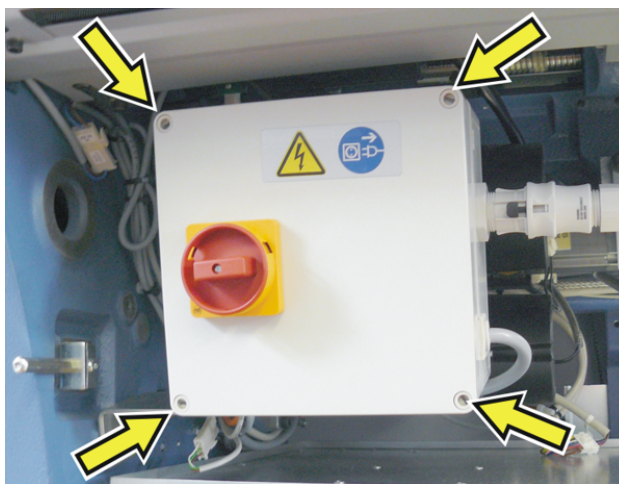

8. Remove the plug (4) from the left side and connect it on the right side.

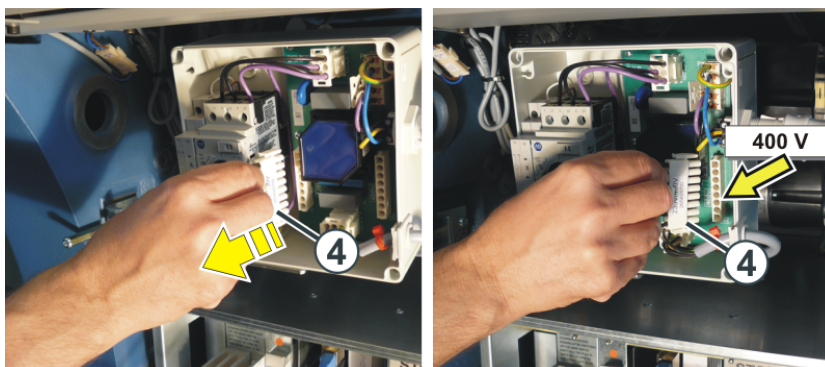

9. Close the main switch.
10. Close the cover at the right control cabinet again.



Adapting fluff absorption to  
mains frequency

Depending on the mains frequency (50 Hz or 60 Hz), the fluff absorption operates with or without sealing plugs.

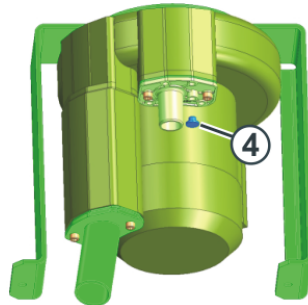

Adapting fluff absorption

---

**i**

The fluff absorption can be damaged if the mains frequency is not adapted!

The fluff absorption is overloaded if it is not adapted to the mains frequency.

-> Adapt the fluff absorption to the mains frequency.

---

1. Open the rear panel segments.
2. Check the sealing plugs (4) of the suction unit.
3. At Mains frequency 50 Hz: Insert sealing plug.  
- or -  
At Mains frequency 60 Hz: Remove sealing plug.
4. Close the rear panel segments.

## 7.2.5 Connecting the knitting machine (mains voltage 230 V / 120 V, "Phase-Phase")

|                                |   |
|--------------------------------|---|
| This description is valid for: |   |
| Mains voltage                  | 230 V / 120 V   |
| Countries                      | e.g. USA, Canada  |
| Machine Type                   | CMS 530<br>CMS 530 W<br>CMS 530 BW<br>CMS 520 C<br>CMS 330<br>CMS 330 W |

|   |   |
|---|---|
|  | <b>DANGER</b>   |
|   | <p><b>Life-threatening high voltage!</b><br/>Electrical shock may cause death or serious injuries.<br/>→ Deenergize on-site mains supply.</p> |

The knitting machine is connected in the following steps:

- Connecting the mains supply
- Adapting the fluff absorption to the mains frequency

Authorized personnel

The knitting machine must be connected by an electrician. Country-specific laws and regulations are to be followed.

Operating the knitting machine with a generator

If the knitting machine is operated with a generator, make sure that the voltage supplied by the generator meets the requirements of the EN 60204-1, Parag. 4.3.1.

In case of queries, please call the Stoll Helpline.

Connect mains supply

**DANGER****Life-threatening high voltage!**

Electrical shock may cause death or serious injuries.

- The knitting machine must be connected by an electrician.
- Country-specific laws and regulations are to be followed.

Lead the mains supply cable to the right control cabinet:

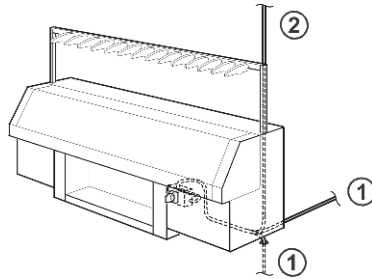

- via the floor (1)
- coming from the ceiling (2) through the right support of the yarn guide device

How to connect the mains supply:

|   |  |
|---|--|
|  | <b>DANGER</b>  |
|   | <b>Life-threatening high voltage!</b><br>Electrical shock may cause death or serious injuries.<br>→ Deenergize on-site mains supply. |

- ✓ The main switch is switched off ("0")
- ✓ The mains supply to the machine is unplugged (currentless)

1. Open the cover at the right control cabinet.
2. Press the release button (1) and unplug the plug (2).

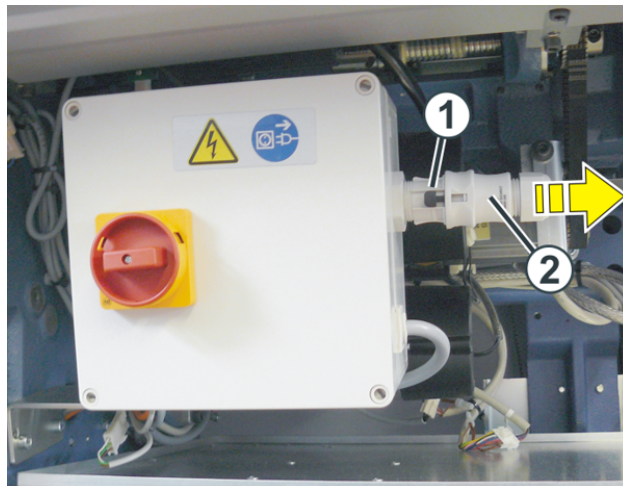

3. Open the plug (2) and connect to the mains supply (3).

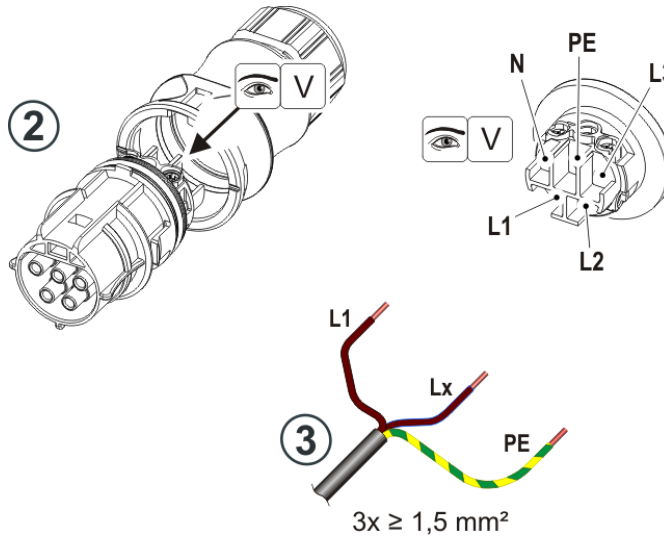

|          | Mains supply (3)   |          |          | Example for mains symmetry |
|----------|--------------------|----------|----------|----------------------------|
|          | Connection variant |          |          |                            |
| Plug (2) | <b>A</b>           | <b>B</b> | <b>C</b> |                            |
| L1       | L1                 | L2       | L3       |                            |
| L2       | -                  | -        | -        |                            |
| L3       | -                  | -        | -        |                            |
| N        | Lx                 | Lx       | Lx       |                            |
| PE       | PE                 | PE       | PE       |                            |

4. Make sure that the operational mains supply is loaded evenly (mains symmetry). You will find the connection variants (**A**, **B**, **C**) in the above table.

**WARNING****Potential equalization missing!**

Serious failures or faults can be caused in the machine and the electronic circuit if the terminal  $\oplus$  (PE) is not connected.

→ Always connect terminal  $\oplus$ .

5. The terminal  $\oplus$  for the protective conductor "PE" must be connected.
6. Close the plug (2) and connect it to the main switch.
7. Open the main switch.  
For this, loosen the 4 screws and remove the cover of the main switch.

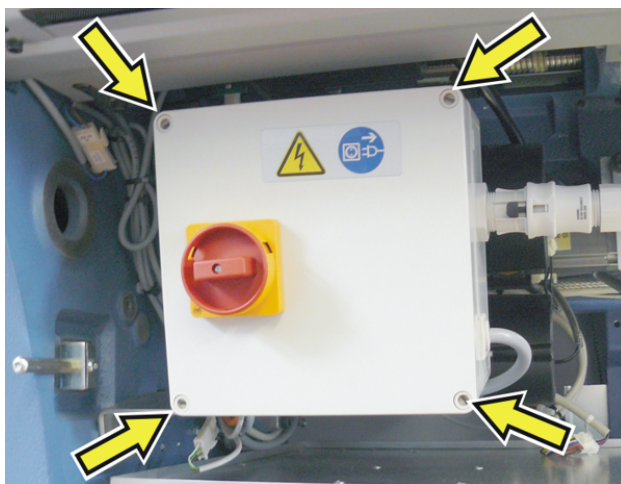

8. Connect the plug (4) on the left side.

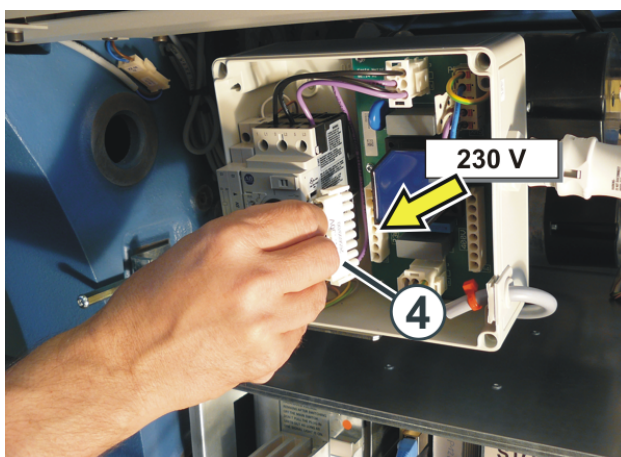

9. Close the main switch.
10. Close the cover at the right control cabinet again.

Adapting fluff absorption to  
mains frequency

Depending on the mains frequency (50 Hz or 60 Hz), the fluff absorption operates with or without sealing plugs.

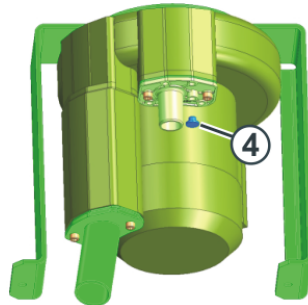

Adapting fluff absorption

---

**i**

The fluff absorption can be damaged if the mains frequency is not adapted!

The fluff absorption is overloaded if it is not adapted to the mains frequency.

-> Adapt the fluff absorption to the mains frequency.

---

1. Open the rear panel segments.
2. Check the sealing plugs (4) of the suction unit.
3. At Mains frequency 50 Hz: Insert sealing plug.  
- or -  
At Mains frequency 60 Hz: Remove sealing plug.
4. Close the rear panel segments.

## 7.2.6 Connecting the knitting machine (mains voltage 400 V, 3 phases)

|                                |   |
|--------------------------------|---|
| This description is valid for: |   |
| Mains voltage                  | 400 V<br>No. of phases: 3<br>Observe right-hand rotating field                    |
| Countries                      | All countries   |
| Machine type                   | CMS 933<br>CMS 822<br>CMS 730 T<br>CMS 830<br>CMS 830 C<br>CMS 830 S<br>CMS 830 W |

|  |   |
|--|---|
|  | <b>DANGER</b>   |
|  | <p><b>Life-threatening high voltage!</b></p> <p>Electrical shock may cause death or serious injuries.</p> <p>→ Deenergize on-site mains supply.</p> |

The knitting machine is connected in the following steps:

- Connecting the mains supply
- Adapting the fluff absorption to the mains frequency

Authorized personnel

The knitting machine must be connected by an electrician. Country-specific laws and regulations are to be followed.

Operating the knitting machine with a generator

If the knitting machine is operated with a generator, make sure that the voltage supplied by the generator meets the requirements of the EN 60204-1, Parag. 4.3.1.

In case of queries, please call the Stoll Helpline.



Connect mains supply

**DANGER****Life-threatening high voltage!**

Electrical shock may cause death or serious injuries.

- The knitting machine must be connected by an electrician.
- Country-specific laws and regulations are to be followed.

Lead the mains supply cable to the right control cabinet:

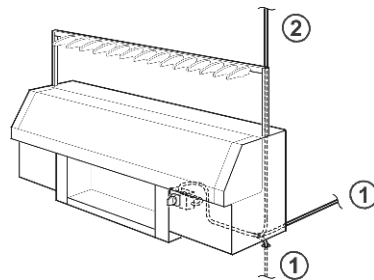

- via the floor (1)
- coming from the ceiling (2) through the right support of the yarn guide device

The machine will be delivered ready to plug. The mains supply cable is fitted with a CEE male plug. The matching female CEE plug (4) is included in the accessories of the machine.

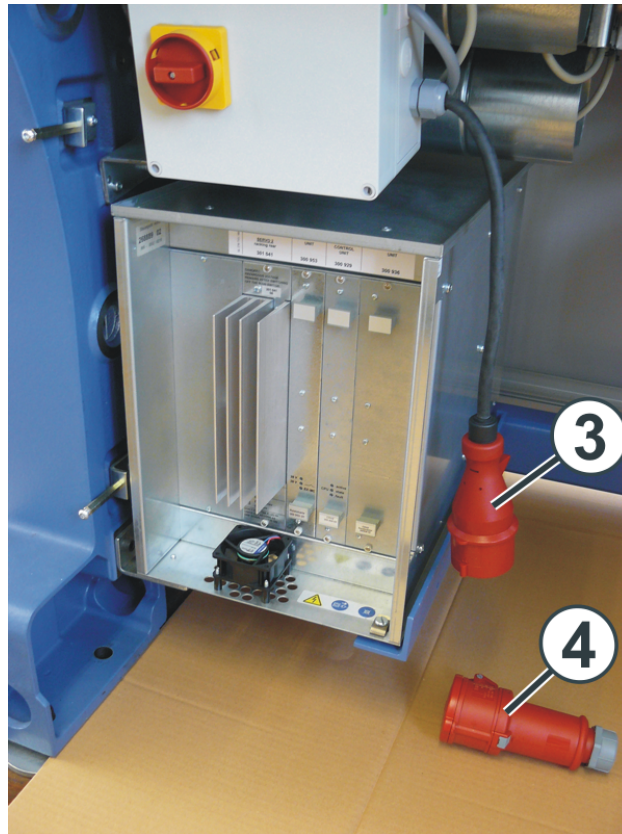

How to connect the mains supply:

1. Determine the direction of rotation of the mains supply.

|   |   |
|---|---|
|  | DANGER  |
|   | <p><b>Life-threatening high voltage!</b><br/>Electrical shock may cause death or serious injuries.<br/>→ Deenergize on-site mains supply.</p> |

2. Open the cover at the right control cabinet.
3. Connect the CEE female plug (4) to the mains supply. The knitting machine must be connected in the right-hand rotating field. Connect the mains supply to the terminals L1, L2, L3 and N (if present) and to the terminal  $\oplus$  for the protective conductor "PE".

---

**i** Potential equalization missing!  
Serious failures or faults can be caused in the machine and the electronic circuit if the terminal  $\oplus$  (PE) is not connected.  
-> Always connect terminal  $\oplus$ .

---

4. Connect the CEE female plug (4) into the plug (3).
5. Close the cover at the right control cabinet again.

The right connection of the mains supply is controlled (right-hand rotating field: Terminals L1, L2, L3 (R, S, T)). If the "24267 Power Supply Phase Sequence Wrong" message appears on the touch screen the connection is wrong.

Correction of the error "24267 Power Supply Phase Sequence Wrong":

|   |  |
|---|--|
|  | <b>DANGER</b>  |
|   | <b>Life-threatening high voltage!</b><br>Electrical shock may cause death or serious injuries.<br>→ Deenergize on-site mains supply. |

→ Swap the two phases of the mains supply.

Adapting fluff absorption to  
mains frequency

Depending on the mains frequency (50 Hz or 60 Hz), the fluff absorption  
operates with or without sealing plugs.

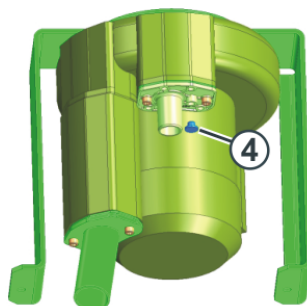

Adapting fluff absorption

---

**i**

The fluff absorption can be damaged if the mains frequency is  
not adapted!

The fluff absorption is overloaded if it is not adapted to the  
mains frequency.

-> Adapt the fluff absorption to the mains frequency.

---

1. Open the rear panel segments.
2. Check the sealing plugs (4) of the suction unit.
3. At Mains frequency 50 Hz: Insert sealing plug.  
- or -  
At Mains frequency 60 Hz: Remove sealing plug.
4. Close the rear panel segments.

### 7.2.7 Connecting the knitting machine (mains voltage 400 V / 230 V)

|                                |  |
|--------------------------------|--|
| This description is valid for: |  |
| Mains voltage                  | 400 V / 230 V                            |
| Countries                      | e.g. Europe, China, Hong Kong            |
| Machine Type                   | CMS 503<br>CMS 502<br>CMS 303<br>CMS 202 |

|   |   |
|---|---|
|  | DANGER  |
|   | <p><b>Life-threatening high voltage!</b><br/>Electrical shock may cause death or serious injuries.<br/>→ Deenergize on-site mains supply.</p> |

The knitting machine is connected in the following steps:

- Connecting the mains supply
- Adapting the fluff absorption to the mains frequency

Authorized personnel

The knitting machine must be connected by an electrician. Country-specific laws and regulations are to be followed.

Operating the knitting machine with a generator

If the knitting machine is operated with a generator, make sure that the voltage supplied by the generator meets the requirements of the EN 60204-1, Parag. 4.3.1.

In case of queries, please call the Stoll Helpline.

Connect mains supply

**DANGER****Life-threatening high voltage!**

Electrical shock may cause death or serious injuries.

- The knitting machine must be connected by an electrician.
- Country-specific laws and regulations are to be followed.

Lead the mains supply cable to the right control cabinet:

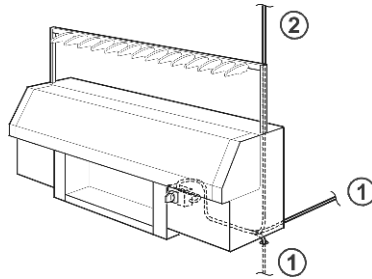

- via the floor (1)
- coming from the ceiling (2) through the right support of the yarn guide device

How to connect the mains supply:



|   |   |
|---|---|
|  | <b>DANGER</b>   |
|   | <p><b>Life-threatening high voltage!</b><br/>         Electrical shock may cause death or serious injuries.<br/>         → Deenergize on-site mains supply.</p> |

- ✓ The main switch is switched off ("0")
- ✓ The mains supply to the machine is unplugged (currentless)

1. Open the cover at the right control cabinet.
2. Connect the mains supply to the plug (1). The plug is located in the accessories of the machine.

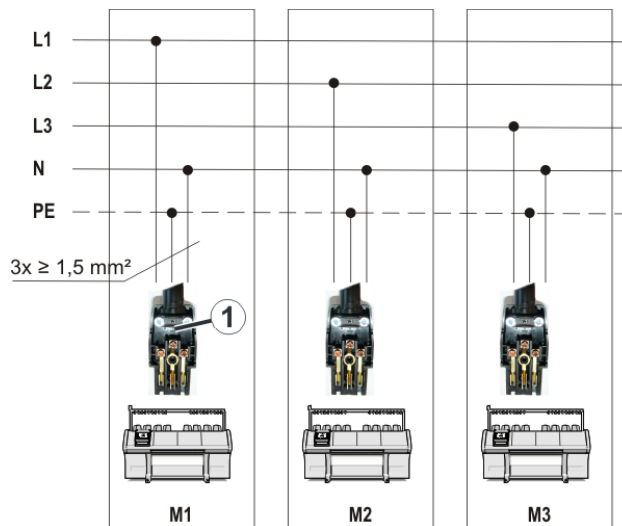
**i** Make sure that the operational mains supply is loaded evenly (mains symmetry).



|   |  |
|---|--|
|  | <b>WARNING</b>   |
|   | <p><b>Potential equalization missing!</b><br/>         Serious failures or faults can be caused in the machine and the electronic circuit if the terminal  (PE) is not connected.<br/>         → Always connect terminal .</p> |

3. The terminal  for the protective conductor "PE" must be connected.

4. Connect the plug (1) to the main switch.

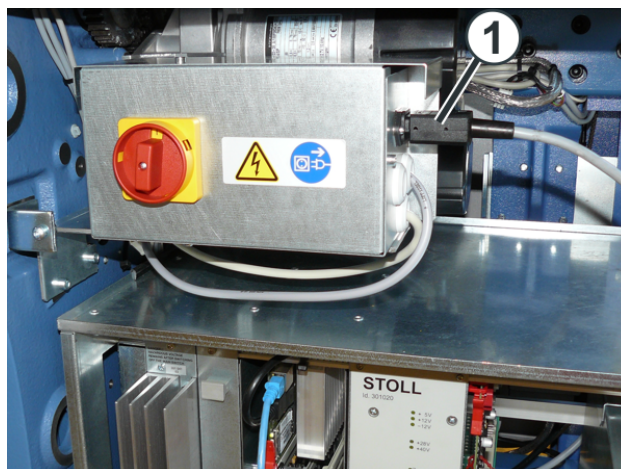

5. Close the cover at the right control cabinet again.



### 7.2.8 Connecting the knitting machine (mains voltage 230 V / 120 V, "Phase-Phase")

|                                |  |
|--------------------------------|--|
| This description is valid for: |  |
| Mains voltage                  | 230 V / 120 V                            |
| Countries                      | e.g. USA, Canada                         |
| Machine Type                   | CMS 503<br>CMS 502<br>CMS 303<br>CMS 202 |

|   |   |
|---|---|
|  | DANGER  |
|   | <p><b>Life-threatening high voltage!</b><br/>Electrical shock may cause death or serious injuries.<br/>→ Deenergize on-site mains supply.</p> |

The knitting machine is connected in the following steps:

- Connecting the mains supply
- Adapting the fluff absorption to the mains frequency

Authorized personnel

The knitting machine must be connected by an electrician. Country-specific laws and regulations are to be followed.

Operating the knitting machine with a generator

If the knitting machine is operated with a generator, make sure that the voltage supplied by the generator meets the requirements of the EN 60204-1, Parag. 4.3.1.

In case of queries, please call the Stoll Helpline.

Connect mains supply

**DANGER****Life-threatening high voltage!**

Electrical shock may cause death or serious injuries.

→ The knitting machine must be connected by an electrician.

→ Country-specific laws and regulations are to be followed.

Lead the mains supply cable to the right control cabinet:

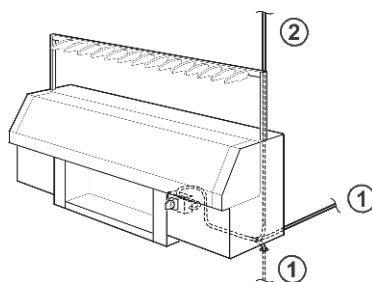

- via the floor (1)
- coming from the ceiling (2) through the right support of the yarn guide device

How to connect the mains supply:

|   |   |
|---|---|
|  | DANGER  |
|   | <p><b>Life-threatening high voltage!</b><br/>         Electrical shock may cause death or serious injuries.<br/>         → Deenergize on-site mains supply.</p> |

- ✓ The main switch is switched off ("0")
- ✓ The mains supply to the machine is unplugged (currentless)

1. Open the cover at the right control cabinet.
2. Connect the mains supply to the plug (1). The plug is located in the accessories of the machine.

**i** Make sure that the operational mains supply is loaded evenly (mains symmetry).

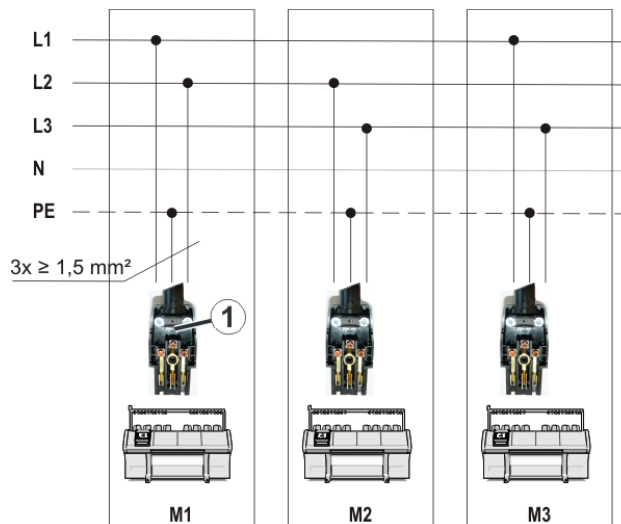

|   |  |
|---|--|
|  | WARNING  |
|   | <p><b>Potential equalization missing!</b><br/>         Serious failures or faults can be caused in the machine and the electronic circuit if the terminal <math>\oplus</math> (PE) is not connected.<br/>         → Always connect terminal <math>\oplus</math>.</p> |

3. The terminal  $\oplus$  for the protective conductor "PE" must be connected.

4. Connect the plug (1) to the main switch.

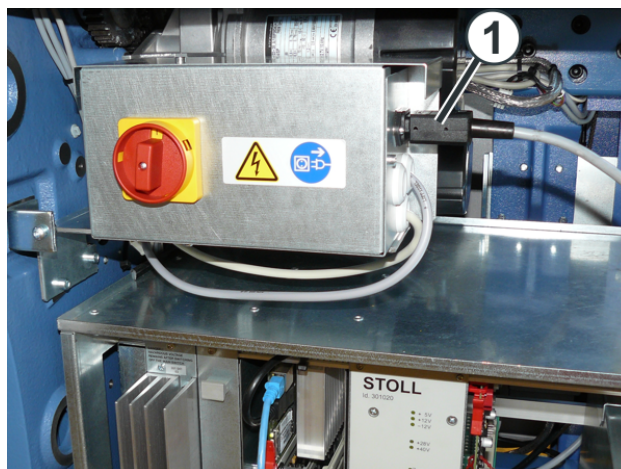

5. Close the cover at the right control cabinet again.

## 7.2.9 Plug in battery pack

The battery pack is unplugged and not charged completely on delivery of the machine.

Machine with movable display

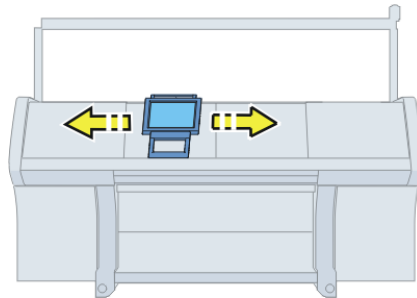

Plug in battery pack:

✓ The main switch is switched off.

1. Open the cover on the control unit.

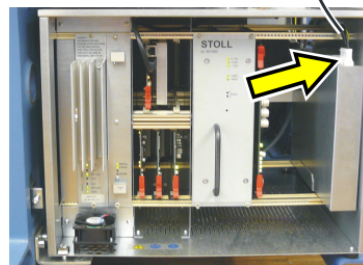
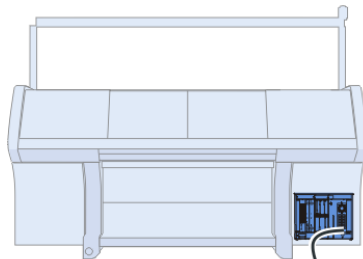

2. Plug in battery pack.

3. Close the cover.

## Assembling machine

Machine with fixed display

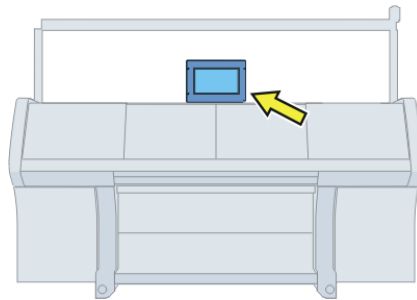

Plug in battery pack:

**i** It is essential to adhere to this order.  
Otherwise, there is a risk that the display will be damaged.

- First plug in the display
- Then insert the battery pack

✓ The main switch is switched off.

1. Plug in display (1).

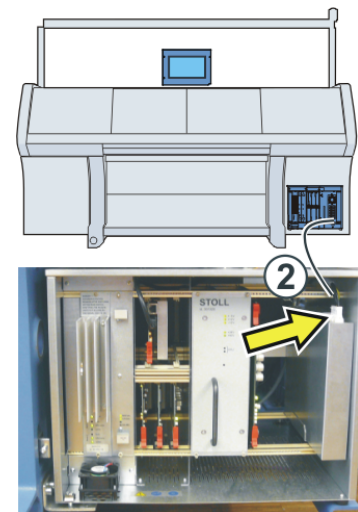
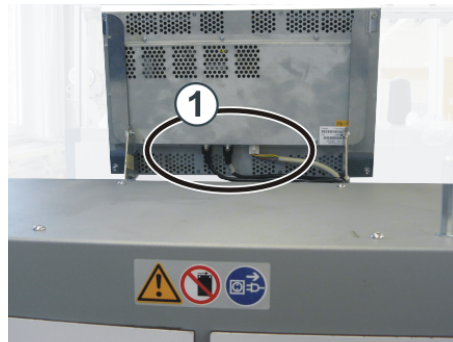

2. Open the cover on the control unit.
3. Plug in battery pack (2).
4. Close the cover.

## 7.2.10 Mounting the yarn guide device



Push the supports of the yarn guide device upward together with another mechanic to prevent the supports from jamming.

- ✓ The main switch is set to "0" and secured against being switched on again.
- 1. Open the lateral safety doors and loosen the screws (1) on both sides of the machine.

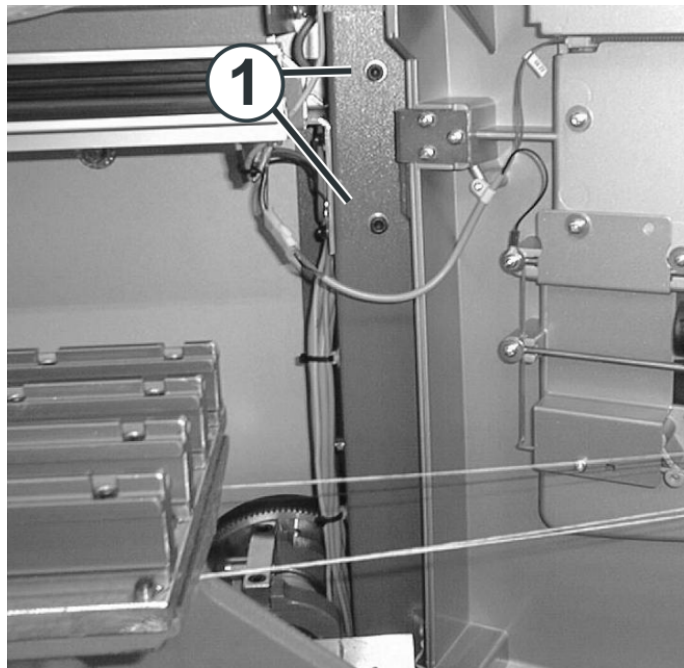

Supports for the yarn guide device

- 2. Push the left and right supports of the yarn guide device upward simultaneously until the distance between the bobbin board and the yarn guide device is 50 to 55 cm.
- 3. Retighten the screws (1) on both sides of the machine.

## Assembling machine

Mounting the rear track of the yarn guide device and the additional bobbin boards

The additional equipment of your machine can deviate from this description depending on the machine type (type of machine, scope of supply, special equipment).

1. Removing transport locks (2).

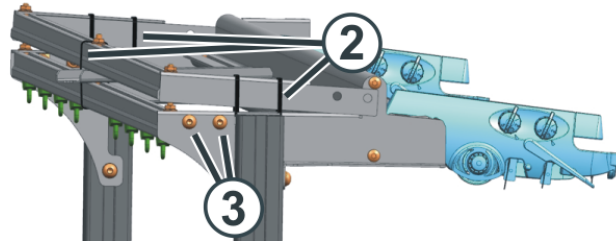

2. Remove the screws (3) on the left and right sides of the machine.

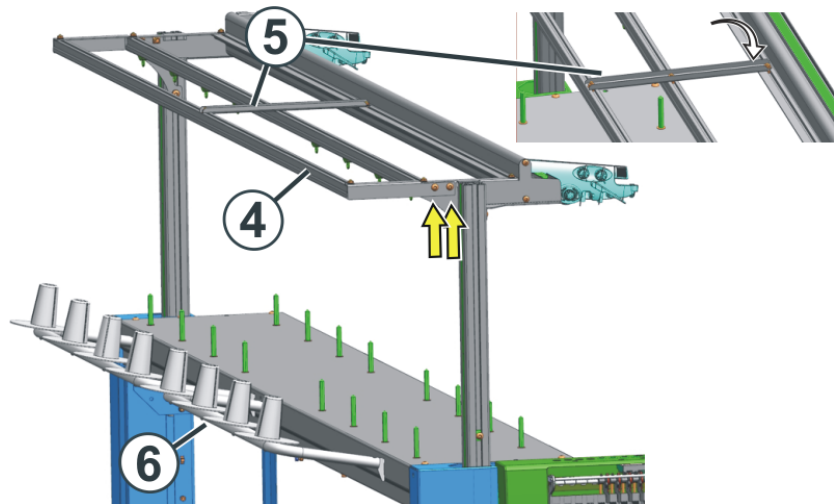

3. Mount the rear track (4) of the yarn guide device.
4. Connect all the tracks of the yarn guide device with the help of the support (5).
5. Hook in both additional bobbin boards (6).



## 7.2.11 Mounting signal light

- i** The power supply for the yarn control devices and the signal light are moved into the supports when the knitting machine is shipped. The signal light from the accessories needs only be connected and screwed into place.



Signal light



Carefully tighten the fastening screw of the signal light to prevent the plastic holder from being damaged.

- ✓ The main switch is set to "0" and secured against being switched on again.
1. Plug the power cable from the right support into the signal light (1).
  2. Screw on the signal light onto the right support with the screws present there.

## 7.2.12 Mounting friction feed wheel

Depending on the machine type, the friction feed wheel is already mounted.

Mounting friction feed wheel:

1. Screw the friction feed wheel on the holder.

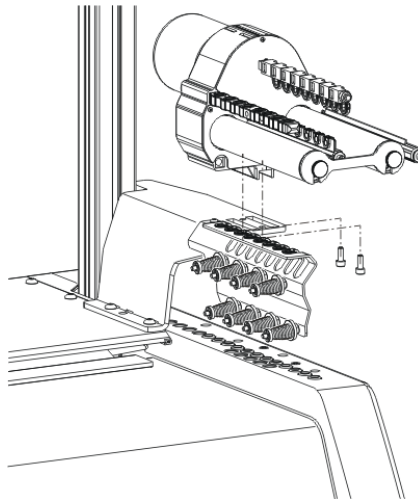

Mounting the friction feed wheel



### DANGER

#### Life-threatening high voltage!

Electrical shock may cause death or serious injuries.

- Set machine main switch to "0".
- Secure the machine against being switched on again.

2. Open the rear panel segments.
3. Route the cable (3) for the friction feed wheel toward the outside through the opening (4).

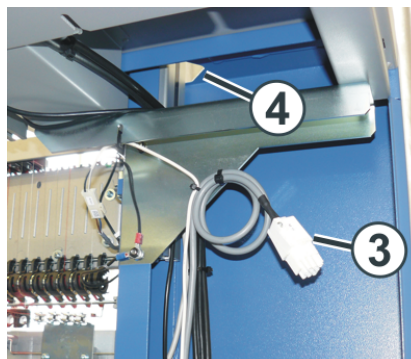

4. Plug the cable into the friction feed wheel.
5. Repeat the process on the other machine side.

### 7.3 Aligning knitting machine

- Preparations
1. Turn the main switch at the front of the machine to 1.
    - ▷ The STOLL logo is displayed.
  2. The "System Control Unit" window is displayed.
 

As soon as the control is ready, the icon (1) changes its color from red to green.

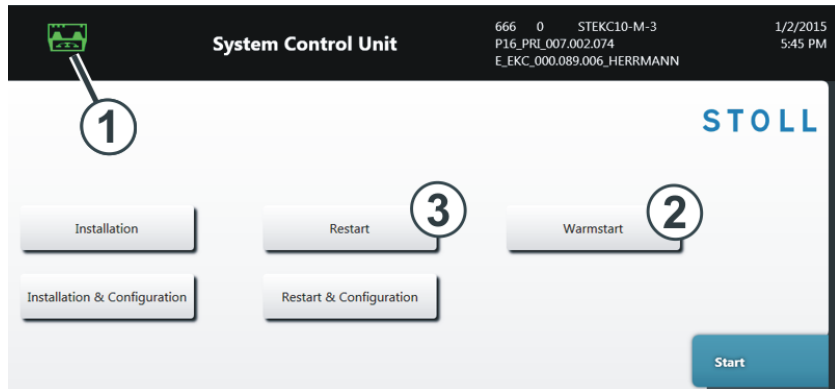

3. The control checks if a "Warmstart" (2) is possible. If the button is inactive (grayed out), no "Warmstart" will be possible, a "Restart" (3) is to be carried out.

|   |   |
|---|---|
| Difference Warmstart < -- > Restart   |   |
| When switching off the machine, all the data will be saved.<br>When switching on the machine, the control checks if all the data does completely exist. |   |
| Data complete   | If the data is complete, then a "Warmstart" will be possible.   |
| Data incomplete   | If the data is incomplete, then a "Restart" will be required.<br>Reason: When switching off the machine, not all the data could be completely saved |

### 7.3.1 Carry out Warmstart

1. Tap "Warmstart" (2) button.

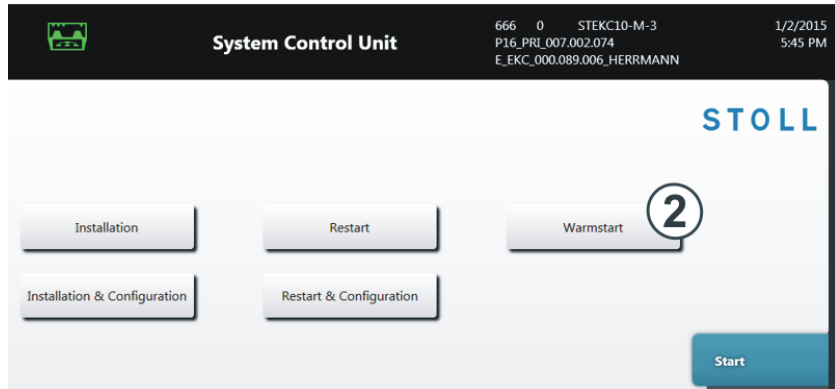

2. You can recognize the control boot at the progress bar.

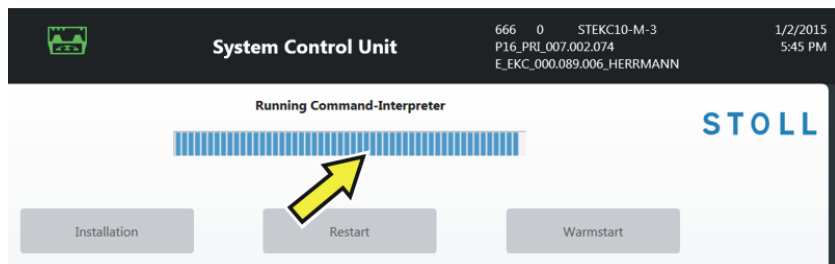

3. The control carries out a configuration automatically.

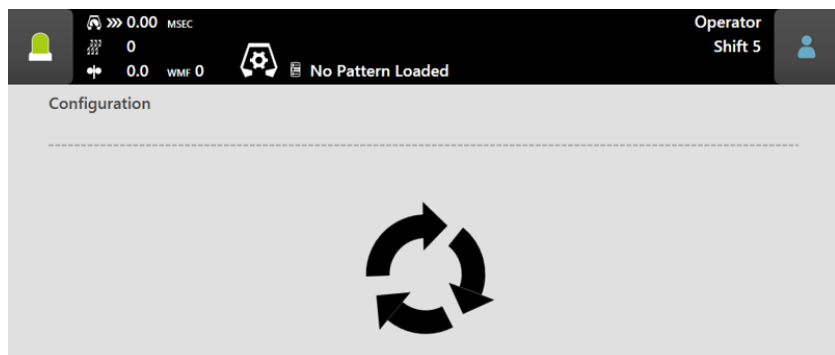

- The "Select a Language" menu appears.  
Select the language which is to be used for the representation of the user interface.

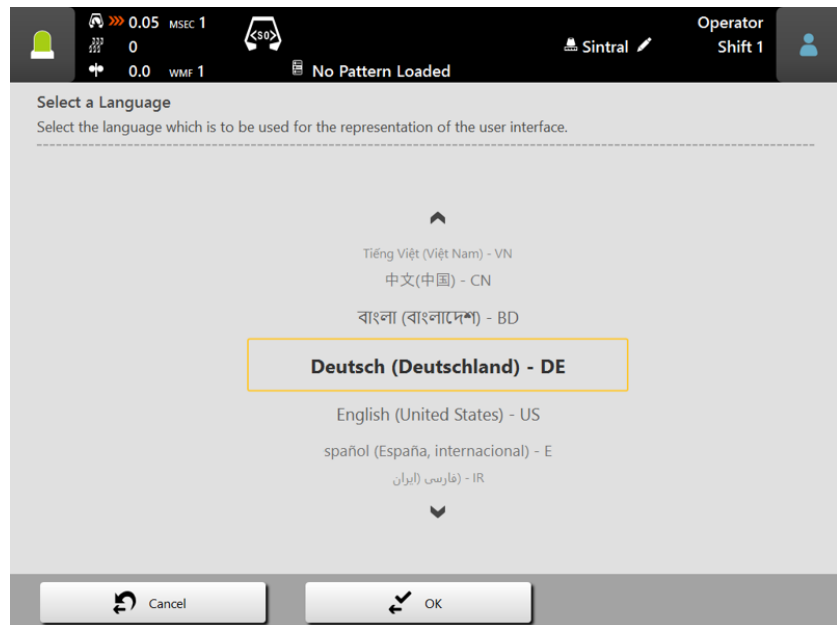

- Confirm the input with "OK".
- If the "Produce Order" menu appears, then the "Warmstart" is finished.



### 7.3.2 Aligning knitting machine

|   |  |
|---|--|
|  | DANGER   |
|   | <p><b>Danger by moving carriage!</b><br/>Injuries by crushing or cutting possible.<br/>→ Close the covers.</p> |

For a machine with weave-in device

Position check of weave-in devices:

- ✓ The covers are closed.
- 1. Pull up the engaging rod.
- 2. A position check will be carried out automatically.  
On the touch screen, the "Weave-in Device: Position Check Active" message appears.
- ▶ After approximately 20 seconds, the position check will be completed.  
You can carrying out the next action step.

Aligning knitting machine

- ✓ The covers are closed.
- ✓ The position check of the weave-in devices has been carried out.
- 1. Pull up the engaging rod.
  - ▷ The step motors are referenced automatically.  
The carriage moves with slower speed to the right.
- 2. If the left edge of the carriage (1) is within the needle bed, press the engaging rod downwards.
  - ▷ The carriage stops.
- 3. Open the covers.
- 4. Lay the spirit level on the support surfaces on the left-hand side of the needle bed.

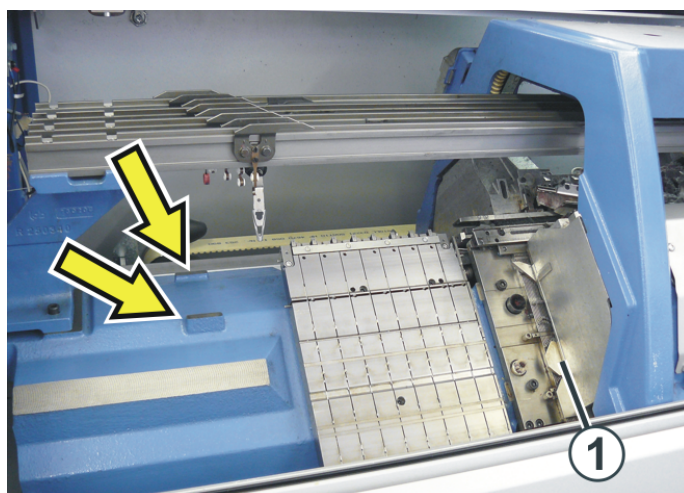

"Carriage in the needle bed" position (the covers were opened for a better overview)

5. Align the left-hand side of the knitting machine with the setscrews. Execute this at the front and rear of the machine. The setscrews for aligning are in the accessories of the machine.



Setscrews for aligning the machine

6. Lay the spirit level on the support surfaces on the right-hand side of the needle bed.

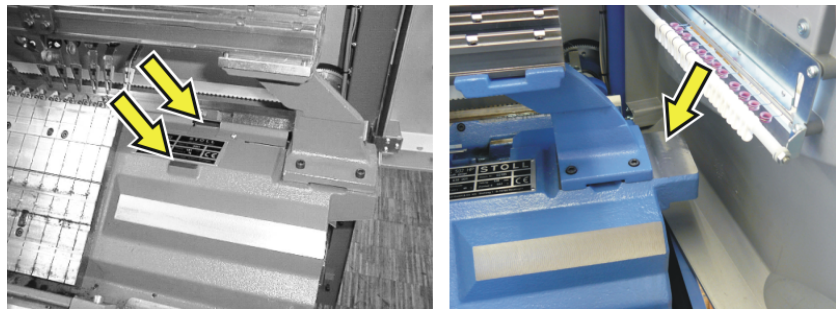

Right support surface for the spirit level (on the right: CMS 502)

7. Align the right-hand side of the knitting machine with the setscrews. Execute this at the front and rear of the machine.
8. Check the setting for the left machine side. Repeat the steps 4 to 7 until no more correction is necessary.
9. Close the covers.
10. Pull up the engaging rod.
  - ▷ The carriage moves with slower speed to the right. The carriage returns outside the needle bed, it moves a short distance and stops. The engaging rod falls down.
11. The step motors and the racking are referenced automatically.
  - ▷ The following message appear on the touch screen:  
Rear racking: Reference run finished
  - ▶ The machine is ready to knit.  
The carriage is positioned at the right position for you to be able to load a knitting program.



The accumulators must be completely loaded.  
Leave machine switched on for at least 6 hours.

---

## 7.4 Check the date and the time

For doing this, proceed as follows:

1. Log in as "Senior Operator", PIN "2222"



2. Open the "Time and Language" menu.  
Path: Configure Machine -> System settings -> Time and Language
3. Check date, time and the time zone
4. Correct the data, if necessary.



## 7.5 Glue on measuring tape

The measuring tape is used to check the fabric length on the machine. It can, for example, be glued on above the engaging rod. You will find the self-adhesive measuring tape in the accessories.



Gluing on the measuring tape

## 7.6 Reducing wear during running-in period

To guarantee an optimal initial setting-up of the machine, the carriage speed is to be limited in the first 100 operating hours.

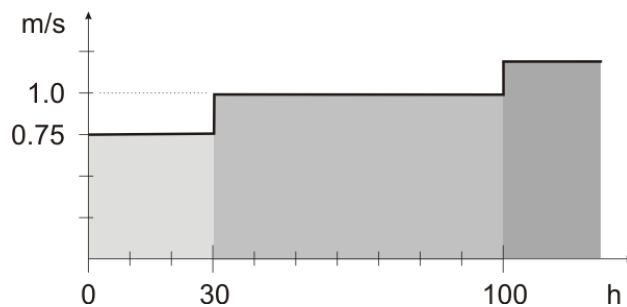

- 30 h: maximum carriage speed: 0.75 m/s
- 70 h: maximum carriage speed: 1.00 m/s

Thereby an optimal running of the machine will be reached, and the wear of the needle beds and the knitting systems will be reduced.

A corresponding message appears on the touch screen.



## 8 How to bring the carriage to an immediate standstill

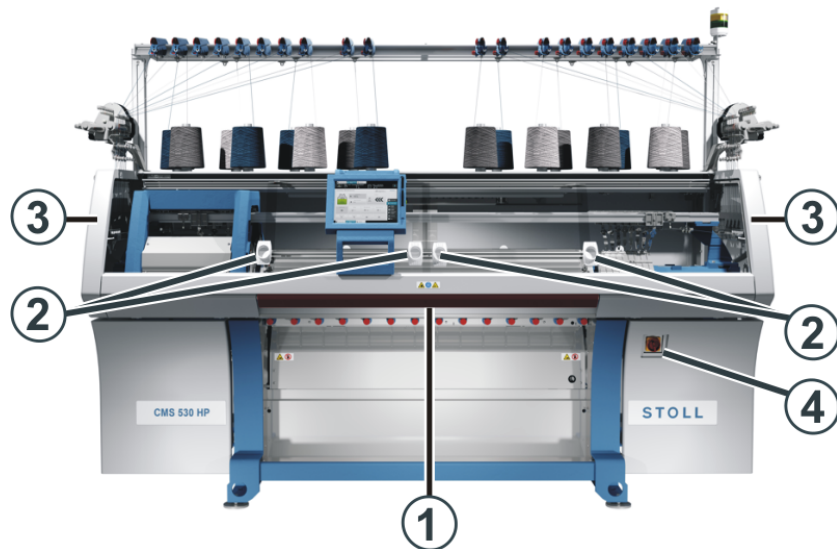

In order to stop the movement of the carriage immediately, carry out one of the following functions:

1. Press the engaging rod (1) downward.
2. Open covers (2).
3. Open safety doors (3).
4. Switch off main switch (4).





## 9 Checking protective devices

Check the protective devices:

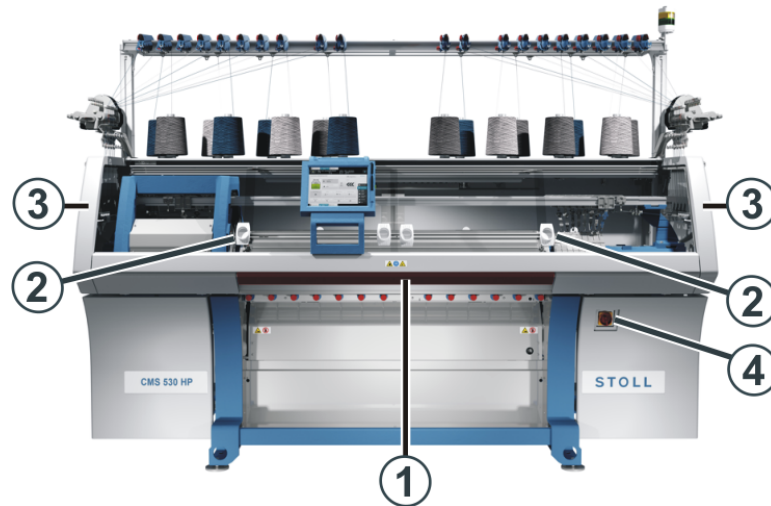
- at every shift change
- at least once a day



|   |   |
|---|---|
|  | DANGER  |
|   | <p><b>Defective protective device!</b><br/>                 Death or serious injury.<br/>                 → If a protective device does not stop the machine, it must be stopped for safety reasons and secured against being started up again. Repair must be carried out immediately.</p> |

|   |  |
|---|--|
|  | DANGER   |
|   | <p><b>Opened covers and safety doors!</b><br/>                 Danger of crushing and cutting by the carriages, racking, fabric take-down, comb take-down and additional beds!<br/>                 → Do not reach into the running machine when the covers and safety doors are open.</p> |

| Protective device | Checking   |
|-------------------|--|
| Engaging rod (1)  | Production setting   |
|                   | <ul style="list-style-type: none"> <li>◆ Pull engaging rod to highest position and release. The carriage starts moving. The engaging rod is held by a magnet.</li> <li>◆ Press engaging rod to bottom position (zero position). The carriage must be stopped immediately.</li> </ul>   |
|                   | Middle position  |
|                   | <ul style="list-style-type: none"> <li>◆ Pull engaging rod to middle position and release. The carriage starts moving. The engaging rod is not held by a magnet, must rather fall back to the zero position. The carriage must be stopped immediately.</li> </ul>  |
| Covers (2)        | <ul style="list-style-type: none"> <li>◆ Pull engaging rod to highest position and release. The carriage starts moving.</li> <li>◆ Open cover. The carriage must be stopped immediately. The engaging rod falls to zero position simultaneously.</li> <li>◆ Close cover anew. To confirm the error message, tap the following button:<br/> <div style="text-align: center; margin: 5px 0;">  </div> </li> <li>◆ Repeat this process for each cover.</li> </ul> |

| Protective device                               | Checking  |
|---|---|
| Lateral safety doors (3)                        | <ul style="list-style-type: none"> <li>◆ Pull engaging rod to highest position and release.<br/>The carriage starts moving.</li> <li>◆ Open the safety door on the right-hand side of the machine.<br/>The carriage must be stopped immediately.<br/>The engaging rod falls to zero position simultaneously.</li> <li>◆ Close safety door anew.<br/>To confirm the error message, tap the following button:<br/> <div style="text-align: center; margin: 5px 0;">  </div> </li> <li>◆ Repeat this process for the safety door on the left side of the machine.</li> </ul> |
| Main switch (4), emergency switching-off switch | <ul style="list-style-type: none"> <li>◆ Pull engaging rod to highest position and release.<br/>The carriage starts moving.</li> <li>◆ Switch off the main switch / emergency switching-off switch (position "OFF").<br/>The carriage must be stopped immediately.<br/>The engaging rod falls to zero position simultaneously.<br/>The machine must switch off automatically.</li> </ul>  |

**Documents about your  
knitting machine**

You can find documents about your knitting machine in the STOLL customer network.

<https://www.stoll.com/en/customer-net/>

